

DISCOVERY

Online Double Conversion UPS

3:3

80 – 120 kVA

Threephase / Threephase



INTRODUCTION

Thank you for choosing our product.

Our company is specialised in the design, development and manufacture of uninterruptible power supplies (UPS).

The UPS described in this manual is a high-quality product, carefully designed and manufactured to guarantee the best performance.

This manual provides detailed instructions for the use and installation of the product.

For information with regards to the use of, and to ensure that you obtain the best performance from your UPS. This manual should be stored near to the UPS and must be READ PRIOR TO PERFORMING ANY OPERATIONS UPON IT.

NOTE: Some of the images in this document are provided as a guideline only, and they may not accurately reproduce the depicted product components.

SAFETY PRECAUTIONS

Read the specific safety manual prior to performing any operations upon the S3T UPS.

This manual must be read in conjunction with the installation manual that contains further information with regards to the safe configuration of the product.

ENVIRONMENTAL PROTECTION

Whilst developing its products, the company takes great care to analyse all environmental issues. All our products seek the objectives defined by the policies of the environmental management system, developed by the company according to the current legislation.

Hazardous materials such as CFCs, HCFCs or asbestos have not been used in this product.

The packaging is made of recyclable material. Please dispose of the individual elements according to the current legislation in force in the country where the product is to be employed. Please refer to *Table 1* for identifying the materials:



DESCRIPTION	MATERIAL	
Pallet	Wood (FOR)	
Packaging box	Corrugated cardboard (PAP)	
Protective bag	High Density Polyethylene (PE-HD)	

Table 1 – Packaging material list

DISPOSAL OF THE PRODUCT

The UPS contains materials which (in case of decommissioning/disposal) are considered TOXIC and DANGEROUS WASTE, for example circuit boards and batteries. Treat such material according to the current legislation by using licensed disposal centres. Their correct disposal helps to protect the environment and human health. If the various components are to be stored, pending admission to landfills, take care to keep them in a safe place and protected from atmospheric agents, to avoid contamination of the ground and ground water (especially with lead and the electrolyte of the batteries).

For further information about the disposal requirements under WEEE regulations please refer to the relative manual.

© The reproduction of any part of this manual, even if partial, is forbidden unless authorised by the manufacturer.
The manufacturer reserves the right to change the product described at any time without prior notice for improvement purposes.

SUMMARY

GLOSSARY OF ACRONYMS	5
PRESENTATION	6
S3T 80/100/120kVA	6
DESCRIPTION	7
GENERAL VIEWS	8
COMMUNICATION	9
COMMUNICATION PORTS	9
UPS OPERATION	10
OPERATING MODES	10
ON LINE MODE	10
ECO MODE	10
SMART ACTIVE MODE	10
FREQUENCY CONVERTER MODE	10
STAND BY OFF MODE	10
OPERATING STATUS	10
NORMAL	10
STAND-BY WITH BATTERY CHARGER OFF	10
STAND-BY WITH BATTERY CHARGER ON	10
BATTERY WORKING	11
TEMPORARY BYPASS	11
MANUAL BYPASS	11
OTHER FEATURES	11
BACK-FEED PROTECTION	11
LATCH-ON-BYPASS FUNCTION	11
POWER WALK-IN	11
DISPLAY	12
OVERVIEW	12
STATUS BAR	12
ICONS AND SYMBOLS	13
ACTIVE TEXT AREAS	14
NAVIGATION	14
SYSTEM HOME PAGE	15
SYSTEM MEASUREMENTS	17
SYSTEM STATUS	18
MENU ENTRIES	20
COMMAND PANEL	20
SYSTEM OFF/ON COMMAND	20
BYPASS COMMAND	21
BATTERY TEST COMMAND	22
BATTERY CHARGER ON COMMAND	22
ALARM TEMPORARY SUPPRESSION	22
GLOBAL SYSTEM INFORMATION	22
MAIN SETUP PAGE	23
LANGUAGE SETTING	24
DISPLAY SETTING	24
System clock	25
Screen saver and buzzer	25
Change password	26
SYSTEM LOG PAGE	26
"EXPERT" LEVEL	27
GENERAL SYSTEM SETTINGS	28
GENERAL CONFIGURATION	28
Operating mode	28
Auto restart	28
Auto power off	29
Enable default IN signals	29
INVERTER OUTPUT SETTINGS	29
Voltage setting	30
Frequency setting	30
BATTERY CONFIGURATION	31
BATTERY TEST SCHEDULING	31
Battery low time	31
ACCESS USERS LEVEL	32
"POWERUSER" LEVEL	32
"USER" LEVEL	32
ACCESS LEVEL SELECTION	33
PASSWORD CHANGE	33

STATUS LED	34
BUZZER	34
CONFIGURING THE UPS FROM DISPLAY	35
DEFAULT SETTING FOR OTHER PARAMETERS	35
DEFAULT CONFIGURATION OF THE INPUT/OUTPUT SIGNALS	36
OUTPUT SIGNALS CONFIGURATION (FACTORY DEFAULT)	36
INPUT SIGNALS CONFIGURATION (FACTORY DEFAULT)	36
INPUT SIGNALS CONFIGURATION (DEFAULT CONFIGURED FROM THE DISPLAY PANEL)	36
OPERATIVE PROCEDURES	37
PRELIMINARY OPERATIONS	37
SYSTEM ON DIRECT COMMAND	38
SYSTEM ON COMMAND VIA BATTERY (COLD START)	39
OPERATIONS CHECKS	40
BATTERY TEST	40
BATTERY WORKING	40
LOAD FORCED ON BYPASS	40
SWITCHING THE SYSTEM FROM ON-LINE TO MANUAL BYPASS	41
EMERGENCY MANUAL BYPASS PROCEDURE	41
RESTORE THE ON LINE MODE AFTER MANUAL BYPASS	42
LOAD ON STATIC BYPASS AFTER MANUAL BYPASS	43
SYSTEM OFF COMMAND	43
POWER OFF THE UPS WITHOUT ACCESS TO THE DISPLAY	43
OPTIONS	44
EXTERNAL BATTERY CABINET	44
BATTERY ROOM VENTILATION	45
SETTING THE RATED BATTERY CAPACITY – SOFTWARE CONFIGURATION	45
EXTERNAL BATTERY TEMPERATURE PROBE	46
EXTENDED RUN-TIME	46
DUAL INPUT	46
REMOTE MAINTENANCE BYPASS	47
EXTERNAL SYNC KIT	48
SUPERCAPACITOR VERSION	48
ENERGYMANAGER FOR LI-ION BATTERIES	48
REMOTE PANEL	48
PARALLEL	49
OPTIONAL SLOT BOARDS	49
FRONT DOOR AIR FILTER	49
IP30 VERSION	49
IPX1 KIT	49
SEISMIC KIT	49
STATUS / ALARM CODES	50
STATUSES	50
COMMANDS	51
WARNING	51
ANOMALIES	52
FAULTS	53
LOCKS	54
TROUBLESHOOTING GUIDE	55
PREVENTIVE MAINTENANCE	58
INTRODUCTION	58
BATTERIES	58
FANS	58
CAPACITORS	58
TECHNICAL DATA TABLE	59

GLOSSARY OF ACRONYMS

Acronym	ITEM	Description
S3T	Three Phase UPS	<i>Three phase output voltage UPS</i>
ER	Extended Runtime	<i>Version with high battery charging current capability</i>
DI	Dual Input	<i>Version with separated lines for Mains and Bypass input connections</i>
SLOT	Expansion Slot	<i>Slot to accommodate the communication cards and relays expansion board</i>
COM	Communication Board	<i>It includes R.E.P.O., IN/OUT signals interface, USB communication port, serial port</i>
PAR	Parallel Board	<i>Communication interface card between UPS for parallel function</i>
SWBATT	Battery Switch	<i>Switch-disconnector with fuses on board to the Battery Cabinet</i>
SWMB	Manual Bypass Switch	<i>Maintenance bypass switch disconnecter</i>
SWIN	Mains Input Switch	<i>Mains input switch disconnecter</i>
SWBYP	Bypass Input Switch	<i>Bypass line input switch disconnecter</i>
SWOUT	Output Switch	<i>Output switch disconnecter</i>
B+	-	<i>Positive battery voltage/current/temp.</i>
B-	-	<i>Negative battery voltage/current/temp.</i>
CB	<i>Battery Charger</i>	<i>UPS internal battery charger</i>

PRESENTATION

S3T 80/100/120kVA

S3T UPS Systems are intended to ensure a perfect supply voltage for the equipment connected to it, both with and without a mains power supply. Once connected and powered, the system generates an alternating sinusoidal voltage, with stable amplitude and frequency, regardless of surges and/or variations affecting the electrical supply.

S3T is the very our latest development resulting in a third-generation transformer-free UPS, originally introduced into the market over twenty years ago.

This ultimate solution is rated at output power factor 1 and defined as ON LINE double conversion technology in accordance with VFI-SS-111 classification (as set out in standard IEC EN 62040-3) and it provides the very highest levels of performance such as:

- **HIGH EFFICIENCY:** up to 96.2% in ON LINE double conversion mode.
- **ULTIMATE TECHNOLOGIES:** S3T applies the advanced technologies such as DSP (Digital Signal Processor), dual core microprocessor, three level inverter circuits and resonant control to provide maximum protection to the critical loads, whilst maintaining optimised energy savings.
- **GRAPHIC DISPLAY:** S3T offers a multiplatform communication choice together with a coloured graphic touch screen display to easily monitor and manage the UPS.

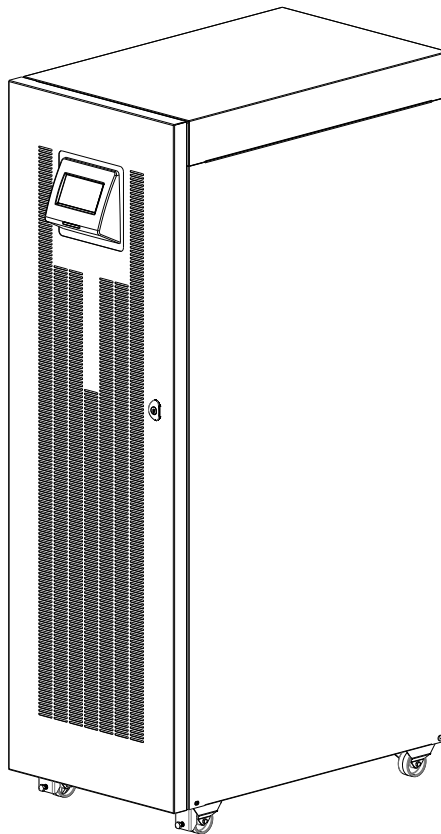

**S3T
(80-100-120kVA)**

DESCRIPTION

Whilst the UPS receives energy from the mains supply, the DSP will ensure that the connected batteries remain charged. The DSP also monitors the amplitude and frequency of the mains voltage, the amplitude and frequency of the voltage generated by the inverter, the load applied, the internal temperature and the condition of the connected batteries.

The block diagrams below show each of the components that make up the UPS for both single and dual input versions.

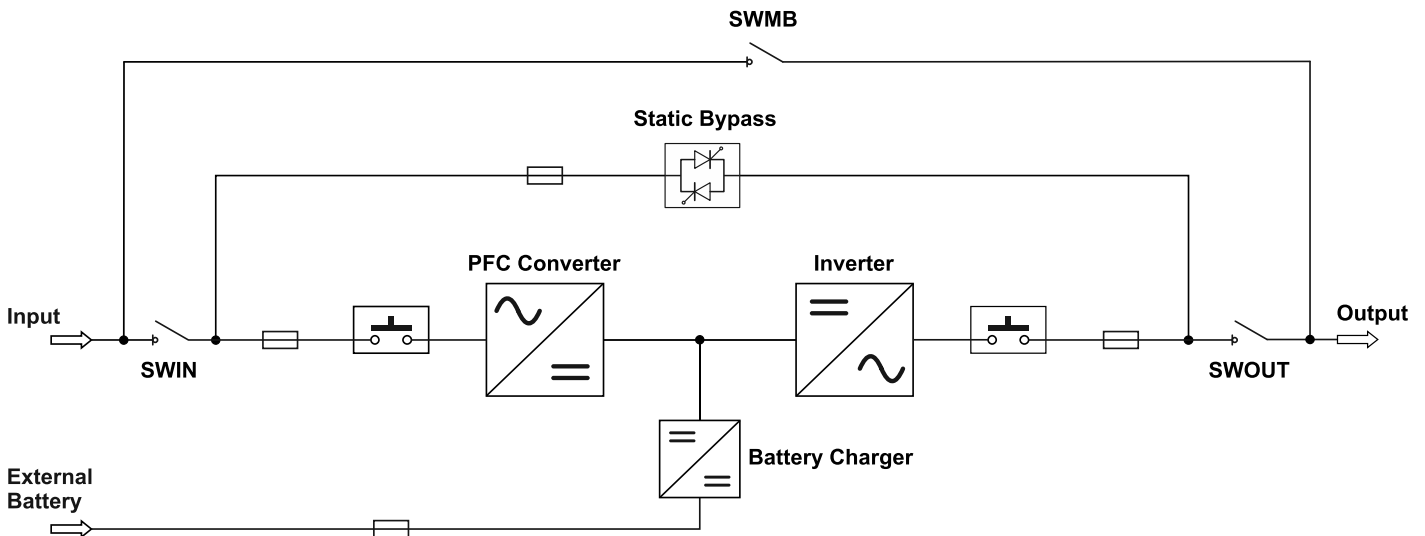

Block diagram showing the single input UPS (without separate bypass)

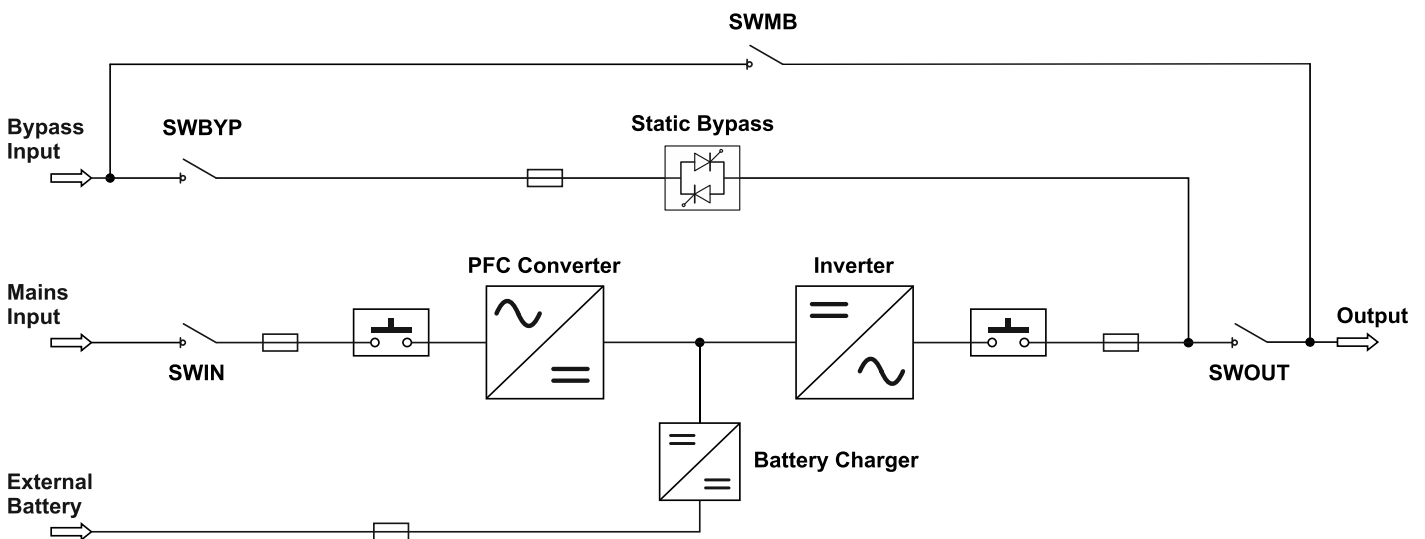

Block diagram showing the dual input UPS (with separate bypass)

GENERAL VIEWS

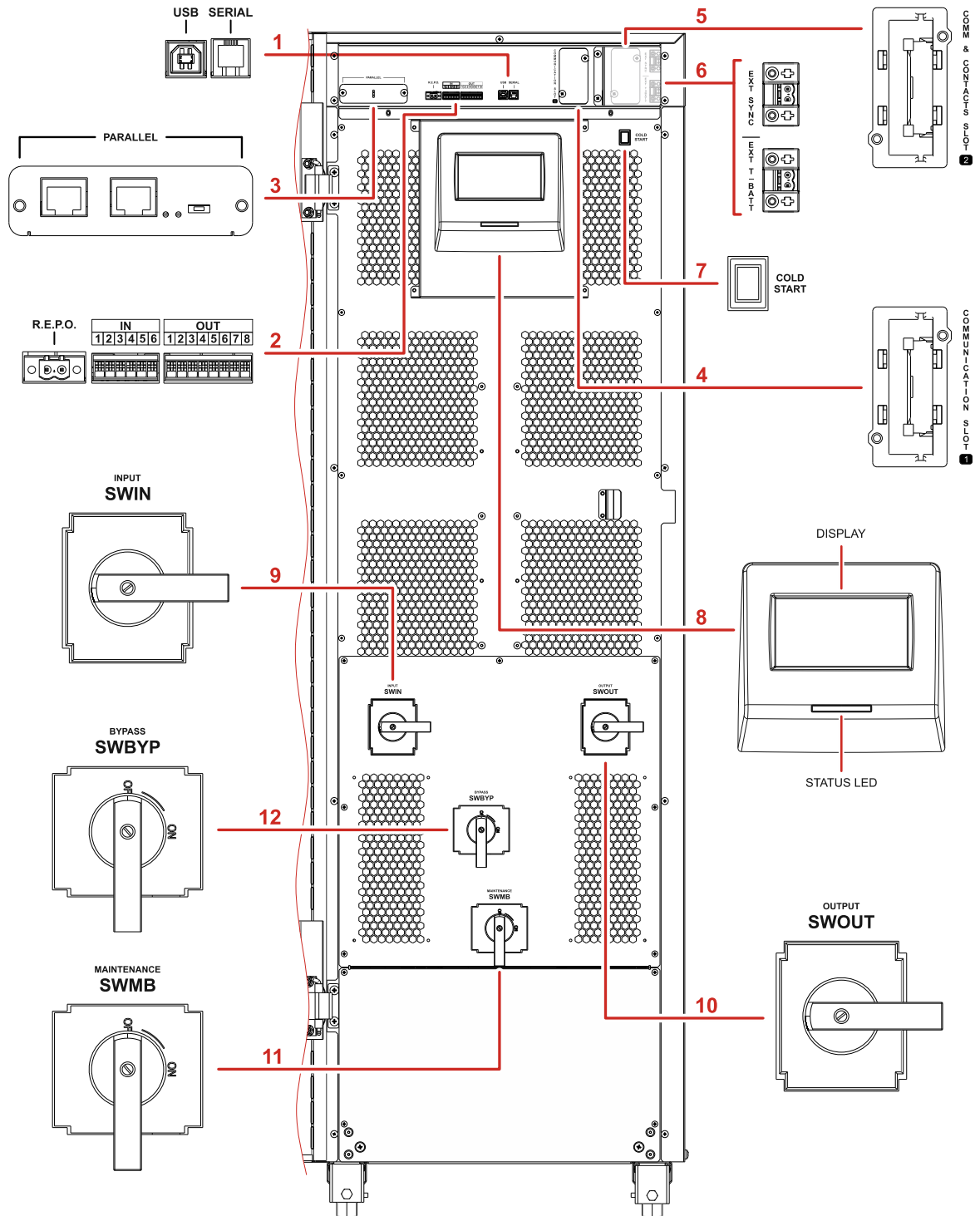

- | | |
|---|--|
| <ul style="list-style-type: none"> 1. Communication ports (USB, SERIAL) 2. Communication ports (R.E.P.O., IN/OUT SIGNAL) 3. Parallel card <i>[optional]</i> 4. Slot for optional accessory communication cards 5. Slot for optional accessory communication and contacts cards 6. External synchronism contacts (EXT SYNC) and external temperature sensor (EXT T_BATT) | <ul style="list-style-type: none"> 7. Battery start button (COLD START) 8. Touch screen display and UPS status LED 9. Mains input switch (SWIN) 10. Output switch (SWOUT) 11. Manual bypass switch (SWMB) 12. Bypass input switch (SWBYP, <i>optional</i>) |
|---|--|

COMMUNICATION

COMMUNICATION PORTS

The communication ports are situated in the top section at the front of the UPS. Refer to the following image for the exact location of each port.

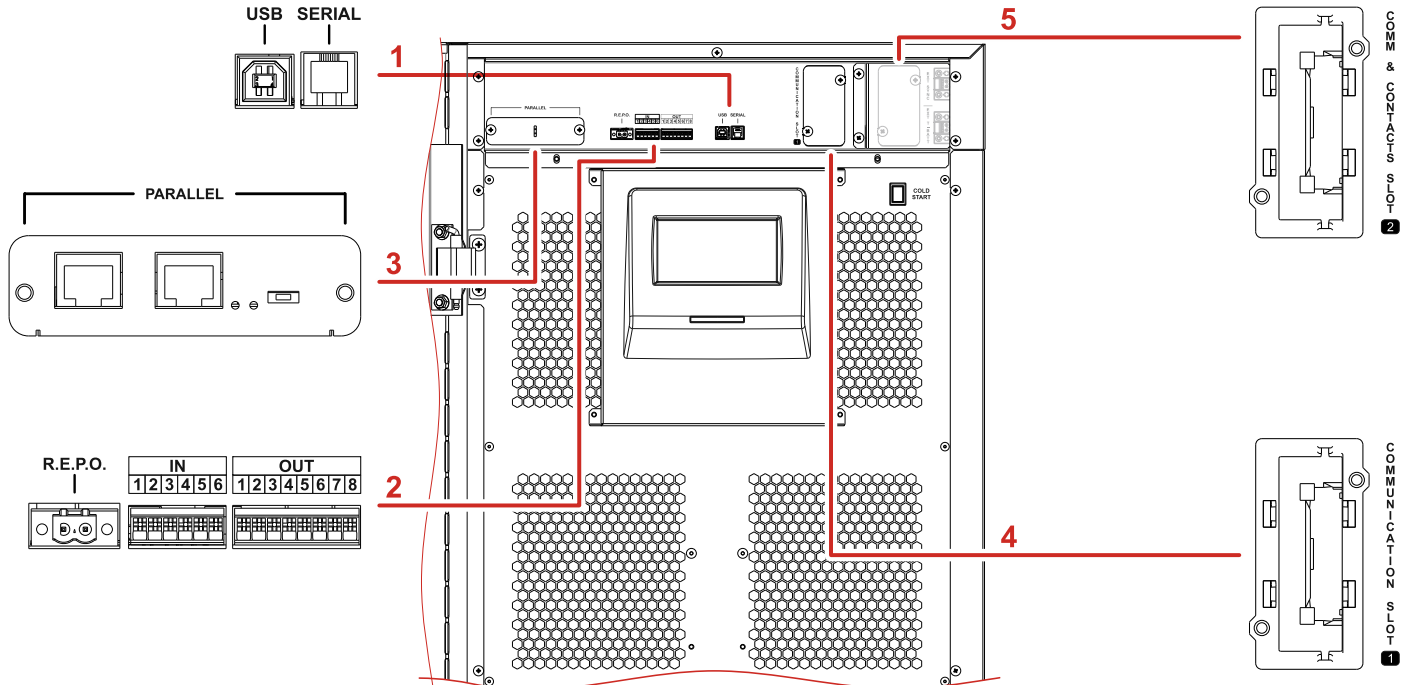

USB / Serial RS232 ports:

These ports allow the UPS to communicate with a computer enabling the system to be monitored and configured.

The two ports cannot be used simultaneously.

- 1** The USB port is to be used as an alternative to the RS232 serial interface. USB port function is only guaranteed when using a cable no longer than 1.5m. If a longer cable is required, the use of the RS232 serial interface is recommended.

R.E.P.O / IN / OUT:

these are digital inputs and dry contact outputs available to the user to perform various functions.

- 2** The R.E.P.O. input is fixed for the Remote Emergency Power Off normally closed contact (the UPS is supplied with a link pre-fitted from the factory as standard).

All the other inputs and outputs can be programmed with the aid of the configuration software. Please refer to the installation manual for more information with regards to the connections.

Parallel board:

An optional parallel board can be fitted into the UPS in order to enable up to eight units S3T to be connected in parallel.

- 3** For further information with regards to this function, please refer to the parallel board kit user manual.

SLOT 2 - Communication and contact Slot:

Slot to accommodate additional communication cards (default configuration), or contacts/relay expansion cards.

- 4** For further information with regards to the communications expansion cards, please refer to the communications card user manual.

SLOT 1 - Communication Slot:

Slot to accommodate the additional communication cards (no contacts/relay card).

- 5** For further information with regards to the communications cards, please refer to the communications card user manual.

UPS OPERATION

OPERATING MODES

The UPS can be configured for different operating modes. The following operating modes as listed below may be selected.

ON LINE MODE

When in ON LINE mode, the system operates in ON LINE double conversion. This mode provides maximum protection for the load. During operation the energy coming from the mains power supply (AC), is converted into a clean and stable output. The voltage supplied to the load is a perfect sinewave, with the frequency and voltage independent of the incoming mains supply (VFI technology). During this mode, the batteries are constantly maintained under charge.

ECO MODE

In order to optimise efficiency, in ECO MODE, the load is normally powered via the bypass (any disturbances that occur within the mains power supply can affect the load). In the event of a mains power supply failure or if the power supply is not within the pre-set tolerances, the UPS will seamlessly switch to ON LINE operation automatically. Approximately five minutes after the power supply returns within tolerance, the load is switched back to bypass.

SMART ACTIVE MODE

The UPS may be set in SMART ACTIVE mode during which, according to the statistical data of the quality of the mains power supply, the UPS will autonomously decide the most appropriate operating mode between ON LINE and ECO MODE.

FREQUENCY CONVERTER MODE

The system can be configured in this mode to generate a fixed output frequency different from the input frequency. This configuration automatically disables the bypass line. FREQUENCY CONVERTER mode can be operated with and without connected batteries.

WARNING: Do NOT switch on the SWMB (manual bypass switch) when the UPS is in FREQUENCY CONVERTER mode.

To prevent maintenance bypass operation, the user shall lock the SWMB switch handle. To first configure this operating mode, open the SWOUT (Output switch).

STAND BY OFF MODE

The UPS is set to operate only in an emergency: when the mains power is present, the load is not powered and the battery remains charged; in the event of a mains supply failure, the load is powered by the inverter from the batteries, and is then powered off once the mains supply returns. The activation time is less than 0.5 sec. When the mains supply returns, the output is powered off after a certain period of time (configurable) has passed. In default configuration, if the mains returns, the output is immediately powered off (default time 0s).

OPERATING STATUS

The UPS may be in a different status for each operating mode explained above. The following is a list of possible operating states.

NORMAL

When the UPS operates "normally" in the selected Operating Mode without any alarm. In this condition the selected "Operating Mode" is displayed in light blue.

STAND-BY WITH BATTERY CHARGER OFF

This is the default status when the UPS is supplied. The UPS is powered but the system is in idle status (no power stages are active).

STAND-BY WITH BATTERY CHARGER ON

When the UPS is supplied, the user can turn on the battery charger without turning on the whole UPS. In this condition the load is not supplied.

BATTERY WORKING

When the UPS is supplying the output with the batteries present, if the mains power supply falls outside the pre-set tolerances, for example in case of a blackout, voltage or frequency disturbance, the system automatically switches to BATTERY OPERATING STATUS and draws power from the batteries to support the load.

Once the mains power supply is again clean and stable, the system automatically returns back to the pre-set operational mode.

TEMPORARY BYPASS

During this operational state, the load is directly powered by the incoming mains supply, therefore, any input disturbances will directly affect the connected load.

MANUAL BYPASS

The manual bypass enables the user to physically connect the UPS input directly to the output. This condition is required to perform maintenance operations on the UPS without the need to disconnect the power from the protected load.

Before closing the manual bypass switch, an auxiliary contact informs the UPS that the load is going to be transferred to manual bypass. This activates an immediate, synchronised transition to the internal static bypass to ensure a safe closure of the manual bypass power contacts.



WARNING: Maintenance work inside the UPS is to be performed exclusively by qualified staff. There may be voltages present within the UPS even when the input, output and battery fuse holders are open. Removal of the UPS panels by non-qualified staff may result in injury to the operator and damage the equipment.

For further instructions in relation to the manual bypass function, please refer to the “Switching the system to manual bypass” chapter.

OTHER FEATURES

BACK-FEED PROTECTION

The UPS has an internal protection against back-feed. This protection acts by means of a sensing circuit which turns off the inverter if a fault within the static switch is detected. In this condition, to avoid interrupting the supply to the connected load, the UPS switches to bypass line.

If the bypass is not available, the connected load is switched off.

To avoid stopping the inverter, a dry contact can be configured to drive a disconnection device. This device must be installed upstream of the bypass input to the UPS, in this case when a back-feed fault occurs, the system opens the external disconnection device (for further information, refer to the configuration software manual).



The label supplied with the UPS must be affixed to all isolators installed in the electrical system upstream of the UPS.

LATCH-ON-BYPASS FUNCTION

The UPS has an internal device (redundant bypass power supply) which activates the bypass automatically when a major failure occurs within the UPS; thus, keeping the load powered without any internal protection and without any limitation to the power supplied to the load.

WARNING: Under these emergency conditions, any disturbance present at the input supply will affect the load.

POWER WALK-IN

The Power Walk-In function can be activated through the configuration software. This function enables, upon reconnection to the power supply (following a mains supply failure), a progressive absorption of power from the incoming supply, in order to avoid stressing (due to the inrush current) a generator or a weak power supply which is potentially installed upstream. The duration of the Power Walk-In mode can be set between 1 to 120 seconds. As default configuration the Power Walk-In is disabled, however the maximum input current is limited. During this mode the required power is partially taken from the batteries and partially from the power supply whilst maintaining a sinusoidal power ramp-up. The battery charger is only switched on once the transition is complete.

DISPLAY

OVERVIEW

The UPS is equipped with a 5" touch screen colour display, through which, amongst others, it is possible to:

- view the status of the system;
- switch on / switch off the system, activate a battery test and perform bypass operation commands;
- configure the system, access levels and the network services.

The "Home" page shows a synoptic diagram of the general operation status of the system. It is possible to interact with the system and access further information via the icons.

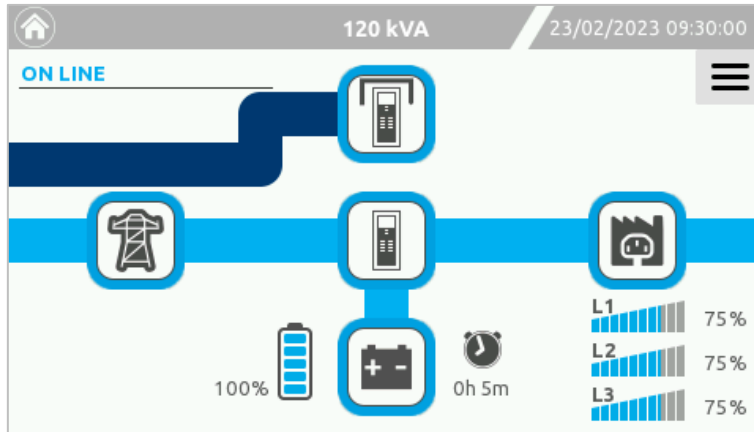

STATUS BAR

The status bar at the top shows the UPS model, the rated power of the system and the system date and time. In the event of an alarm an exclamation mark will also be present indicating the number of alarms active at that time.



In parallel system configuration, the status bar shows "-M" if the UPS is master or "-S" if the UPS is slave. From the top of the status bar the user can access the anomaly/alarm log by pressing the "Exclamation mark" icon. The "Exclamation mark" icon will only be visible if an anomaly, warning, lock or command occurs.



Icon indicating the existence and number of alarms that are active at that time. If you tap on the icon, a pop-up will appear showing the individual alarms in detail. To close the pop-up, tap the "exclamation mark" icon again.

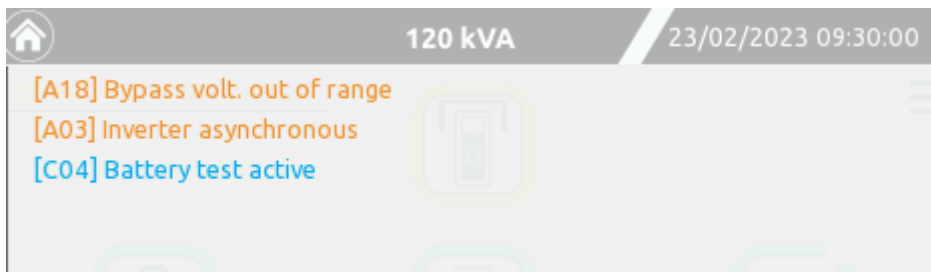

In the list of alarms:

- Blue messages indicate warning (W) alarms;
- Orange messages indicate anomalies (A) alarms;
- Red messages indicate lock (L) alarms and faults (F) alarms.

For the alarm code list, refer to the "STATUS/ALARM CODES" chapter.

ICONS AND SYMBOLS



System input/mains status



% Battery charge level



System output status



75%

% Phase 1 load level



Bypass status



75%

% Phase 2 load level



Battery status

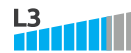

75%

% Phase 3 load level



System status



Manual bypass switch closed (SWMB)

In general, the color and the shape of the icons provide instant information to the status of the system.



Grey: communication lost (Com-Lost)



Orange: anomaly



Light blue: normal status



Flashing red: alarm



Blue: Temporary bypass status

ACTIVE TEXT AREAS

ON LINE

Mains Input

System Status: area of the display reserved for the description of the system status. If the UPS is in NORMAL MODE this area will indicate the current operating mode, or another operational system state. NORMAL MODE means that the UPS is working in the expected operational state for the configured operating mode (e.g. when in ON LINE mode the expected status is “Load on Inverter”, during ECO MODE the expected operating state is “Load on Bypass”)

Mains Input: Area of the display reserved for displaying the main electrical values related to the input to the system.

Battery

Battery: Area of the display reserved for displaying the main electrical values related to the battery.

Bypass Input

Bypass input: Area of the display reserved for displaying the main electrical values related to the bypass line.

Output

Output: Area of the display reserved for displaying the main electrical values related to the output of the system.

NAVIGATION

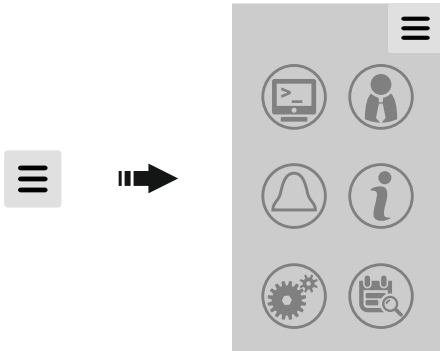

Menu expansion / reduction tab icons (the menu reduces automatically after a few seconds). The menu may change depending on the pre-set access level.



HOME

Press this icon to close the currently selected page and return to the Home page.



RETURN

Press this icon to go back to the previous page.



SAVE

Press this icon to save any changes.



EXIT WITHOUT SAVING

Press this icon to exit without saving changes.

SYSTEM HOME PAGE

The home page provides a schematic view of the overall operating condition of the system. It is possible to interact with the system and access further information via the icons.

Depending on the current state of the system, this page may assume different appearances as shown in the examples below. The user can return on the home page at any time by tapping the “Home” icon on the status bar.

The following are some examples of the home page whilst displaying various operating conditions:

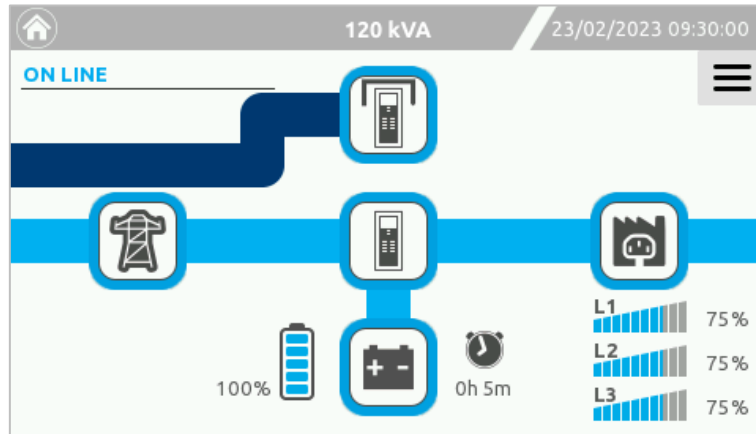

Home page displaying UPS in ON LINE mode (normal operation, load on inverter).
- DUAL INPUT version -

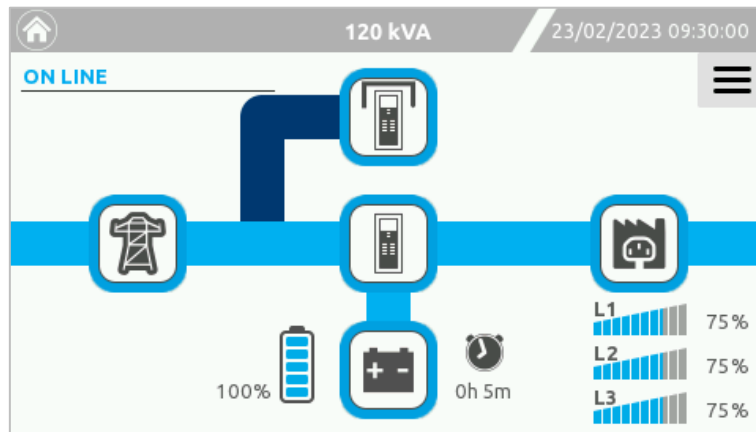

Home page displaying UPS in ON LINE mode (normal operation, load on inverter).
- SINGLE INPUT version -

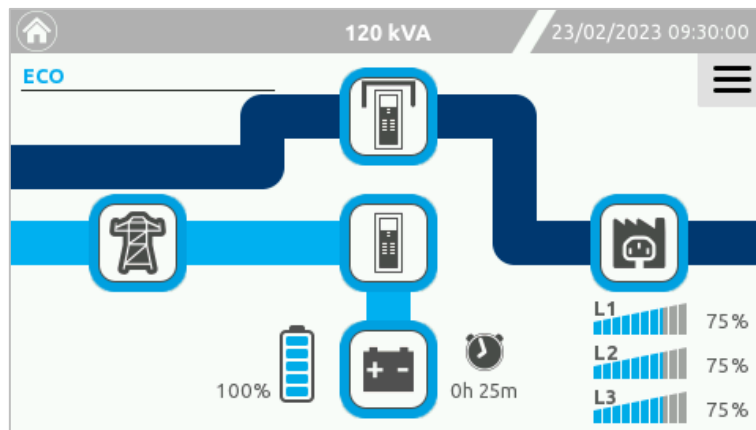

Home page displaying UPS in ECO mode (normal operation, load on static bypass).

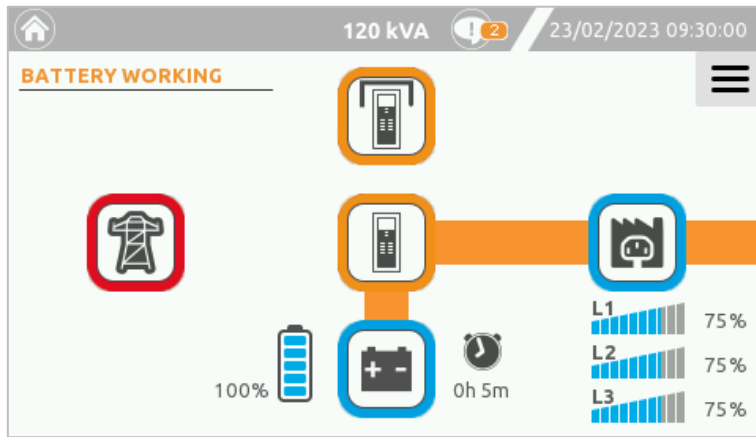

Home page displaying BATTERY WORKING status.

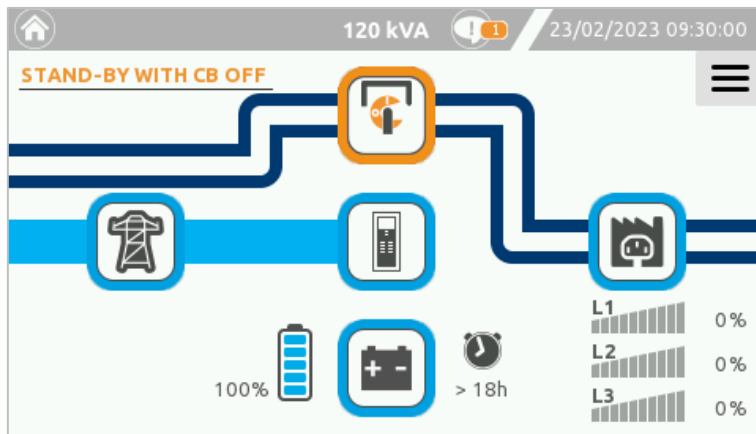

Home page displaying MANUAL BYPASS SWITCH CLOSED.

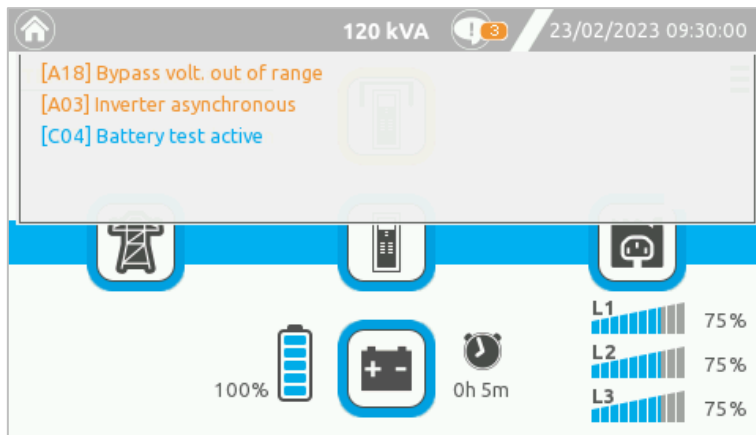

Home page with alarm drop-down list opened.

SYSTEM MEASUREMENTS

The pages that display the main electrical values of the system can be accessed through the icons in the Home page:

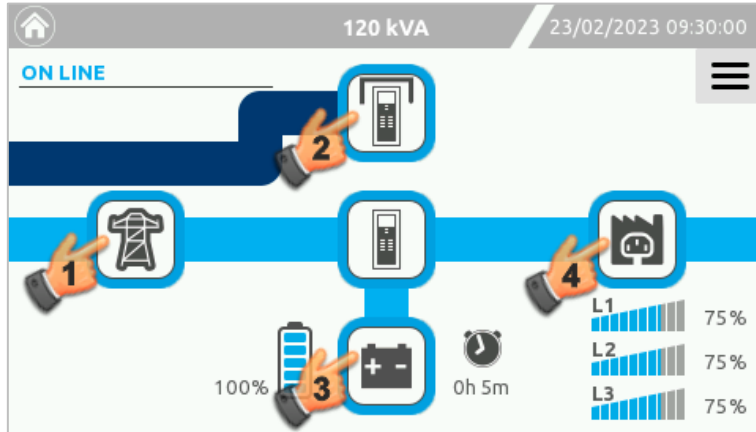

Pressing one of the four section icons Input (1), Bypass (2), Battery (3), Output (4) will open the relative measurements page.

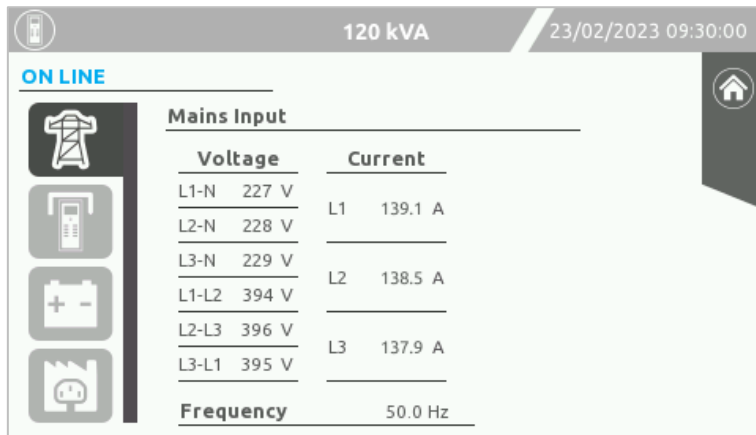

Mains Input page: displays the status and the parameters relating to the system input.

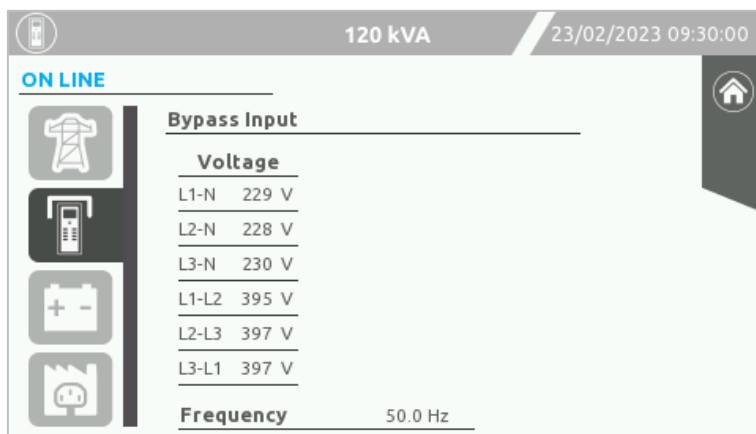

Bypass section page: displays the status and the parameters of the system bypass line.

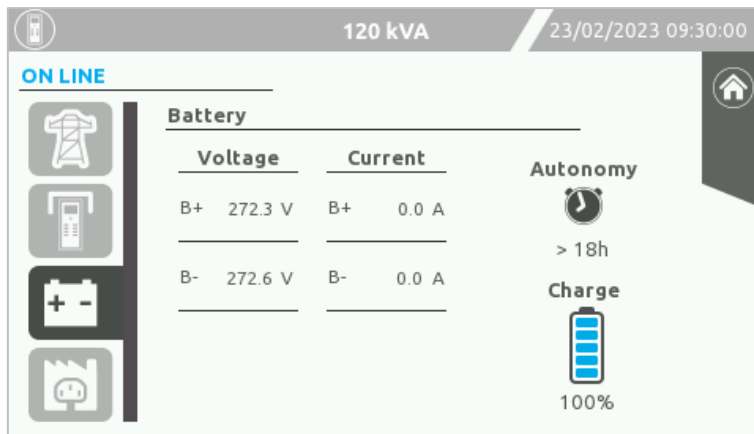

Battery status page: displays the status and the parameters related to the system batteries.

On the left are shown the voltages of the positive (B+) and negative (B-) battery banks. The battery currents, displayed on the right, have a positive symbol if the UPS is working from battery, whilst the symbol is negative if the battery is under charge.

The charge level is estimated by an algorithm that computes the energy flowing to and from the batteries and the voltage level. The autonomy is calculated based on the actual power supplied to the load and the charging level.

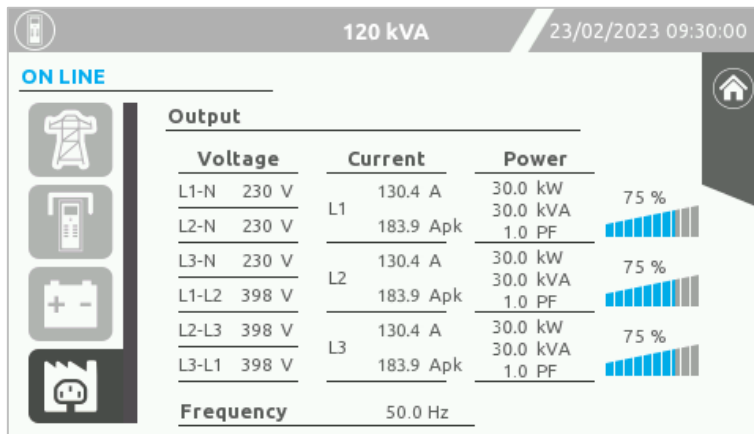

Output status page: displays the status and the parameters of the system output.

SYSTEM STATUS

Pressing the System icon will give access to the switch status tabs, sensor status or internal status pages.

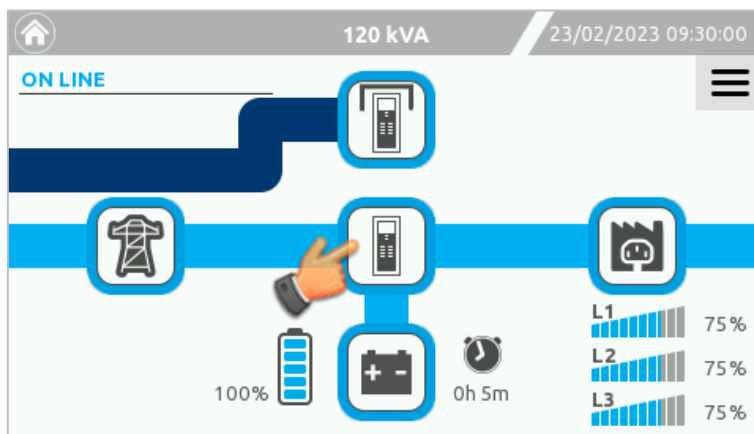

Internal		External	
SWOUT	CLOSED	SWIN	---
SWMB	OPEN	SWBYP	---
		SWOUT	---
		SWMB	---
		SWBAT	---
		SWBAT2	---

Switch status page: displays the status of the UPS internal switches and the optional external switches. The external switch auxiliary contacts must be connected to the digital inputs and programmed using the configuration software.

Temperature	
System	28 °C
Boost	46 °C
Inverter	49 °C
CB	--- °C
Ext-Bat	26 °C

Sensor status page: displays the temperature of the system and of the power heatsinks. The Ext-Bat value will be shown if a Battery Cabinet external temperature probe is installed and set by the configuration software.

Input contact	CLOSED	Boost pfc	ON
Batt. contact	OPEN	Boost batt	OFF
Output contact	CLOSED	Inverter	ON
Bypass contact	OPEN	Batt. charger	ON
Dc bus +	381 V	Dc bus -	381 V

Internal status page: displays the status of the UPS internal contacts, the status of power stages and the DC bus voltage.

MENU ENTRIES

The main menu can be accessed through the menu icons  displayed on the right.

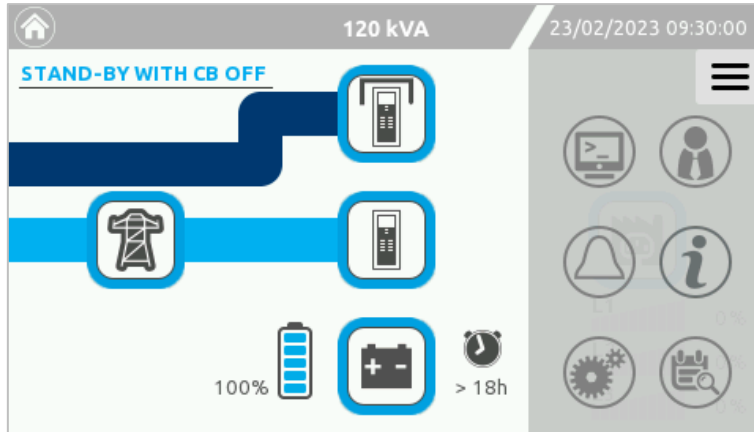

Command launcher



Access level selection.
The icon changes depending on the preset access level



Buzzer toggle button



UPS info



Settings menu



Event log

COMMAND PANEL

To access the Command Panel, tap the Command launcher icon.



From this page, it is possible give commands to the UPS:
System commands and Battery commands.

SYSTEM OFF/ON COMMAND

Tap the "System Off/On" icon to switch the system on.

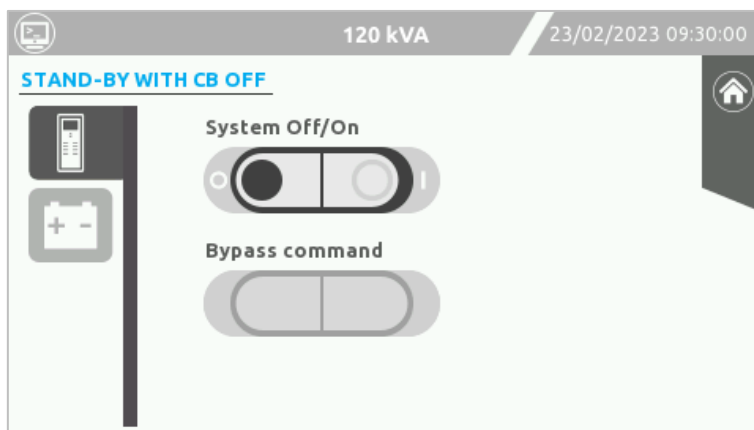

System commands page

A confirmation of the action is required for some of the commands. Press “OK” to confirm the operation.

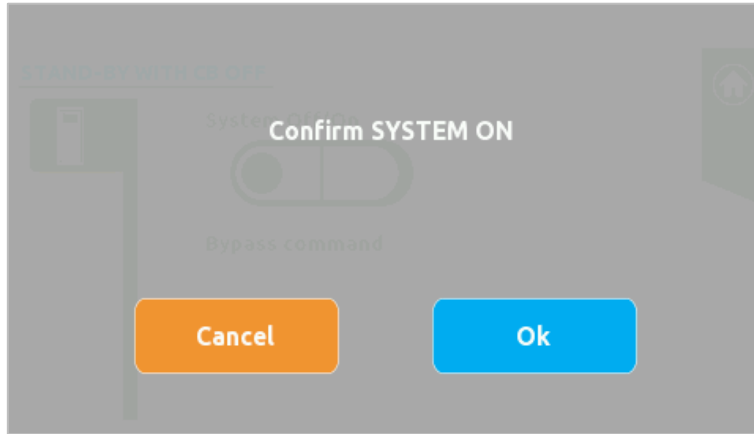

System on confirmation

After pressing the OK button in the confirmation window, a bar will show the progress of the command completion.

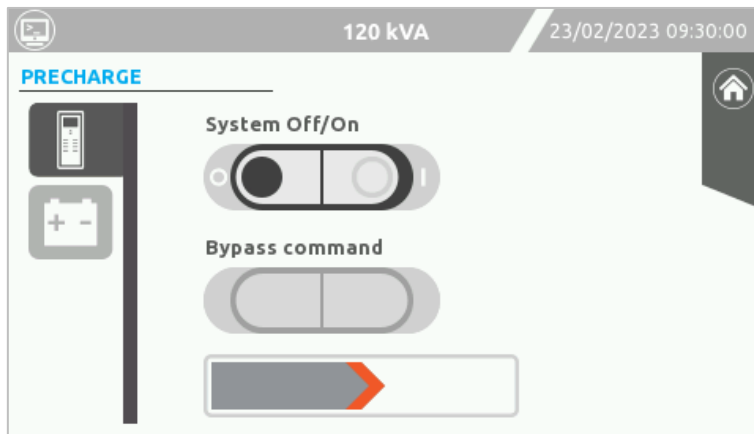

Progress bar during a system start-up sequence.

NOTE: When there is a R.E.P.O. condition, the command panel operations are inhibited. To continue, remove the R.E.P.O. condition and select the system off command to reset the alarm.

BYPASS COMMAND

Press the “Bypass command” icon to switch the system on to static bypass. A confirmation is required.

NOTE: This command is available only if the system on command is activated and, if enabled, the system will be switched into bypass. If the system is in Stand-by mode, the command is disabled.



Press the bypass command “O” to switch the load back onto the inverter.

WARNING: In this condition, a power outage will lead to a loss supply to the connected load. The UPS will behave in different ways depending on the operational status it is in.

- Bypass command when running in ON LINE mode: the system is switched to bypass and the inverter is shut down.
NOTE: if bypass is not available this command is not executed.
- Bypass command when running in ECO MODE: the UPS is normally on bypass. If the bypass command is activated, the output relay is opened and the UPS is no longer able to switch into battery status. The system is switched onto bypass.
- Bypass command from Stand-by off mode: the load is supplied from bypass and the system is switched onto bypass. This function can be useful for lamp testing in emergency lighting systems.
- Bypass command from frequency converter mode: the command is disabled. When working in frequency converter mode any operation with the bypass is not possible.

BATTERY TEST COMMAND

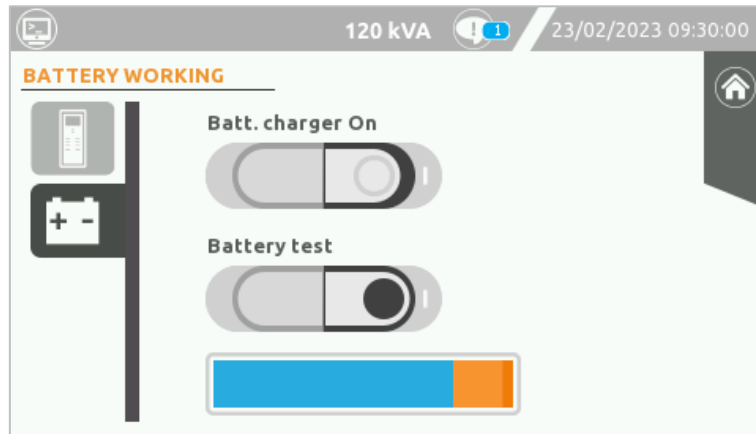

Battery commands page

S3T UPS are equipped with a built-in battery test function. This function forces the UPS to work from battery and monitors the battery voltage under load to check if the battery is healthy.

NOTE: the UPS switches to battery just for the short time needed to execute the battery test and only when the main supply is present as backup, therefore the battery charge level and the load safety are not compromised. The battery test is activated only when the UPS is ON, the SWOUT is closed and the battery charge level is $\geq 90\%$. Otherwise, the test will not be executed immediately, however the command remains active and the battery test will start as soon as these conditions are met.

Press the “Battery test” icon to execute the battery test. A confirmation is required. The progress bar will show the progress of the battery test.

BATTERY CHARGER ON COMMAND

Tap the “Batt. charger On” command to turn on the battery charger when the UPS is in stand-by mode to enter STAND-BY WITH BC ON mode (a confirmation is required) In these conditions the UPS output is not powered but the battery is under charge.

ALARM TEMPORARY SUPPRESSION



If the system buzzer is beeping due to a prolonged fault state, the user can silence the alarm by pressing the Buzzer toggle button. For further information refer to the “buzzer” paragraph in the “user interface” Chapter.

GLOBAL SYSTEM INFORMATION



This page displays general information about the system.

Expand the drop-down menu  on the Home page and touch the information icon.

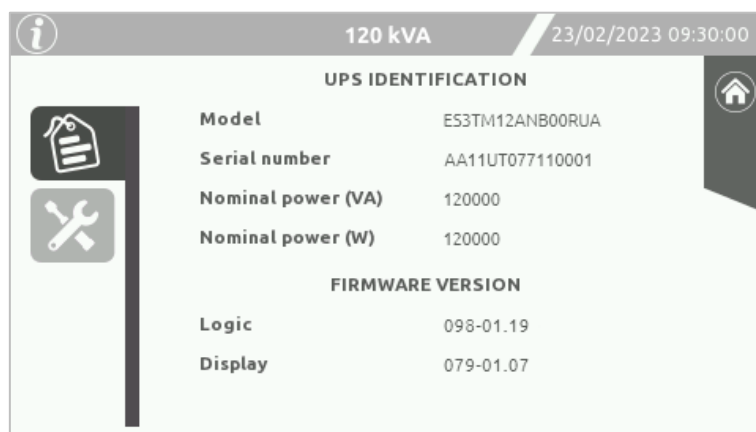

UPS identification

This page displays the following information:

- Model: the Manufacturer's part number.
- Serial number: the UPS identification number.
- Nominal power (VA): the UPS rated apparent power, in VA.
- Nominal power (W): the UPS rated active power, in W.
- Logic: the DSP firmware version.
- Display: the touch screen display firmware version.

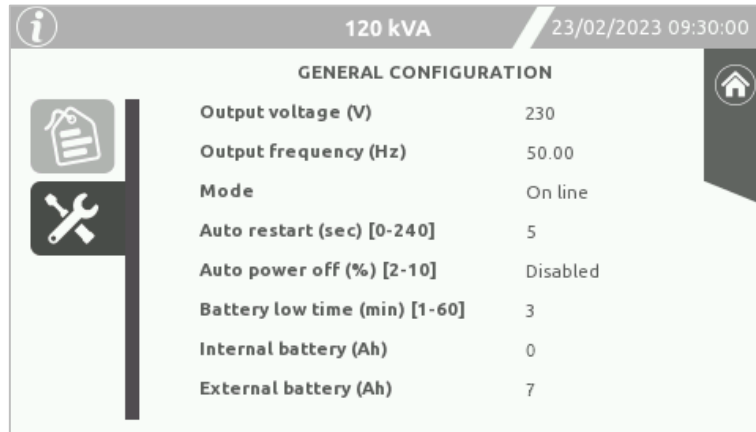

GENERAL CONFIGURATION	
Output voltage (V)	230
Output frequency (Hz)	50.00
Mode	On line
Auto restart (sec) [0-240]	5
Auto power off (%) [2-10]	Disabled
Battery low time (min) [1-60]	3
Internal battery (Ah)	0
External battery (Ah)	7

General configuration

This page shows the general configuration of the UPS:

- Output voltage: the set UPS r.m.s output voltage (in Volts).
- Output frequency: the set UPS output frequency (in Hz).
- Mode: the operating mode set by the user.
- Auto restart: the set time delay between the detection of the line presence and the automatic UPS turn-on (in seconds).
- Auto power off: the set load percentage below which the UPS shuts down.
- Battery low time: the set remaining battery time for which the buzzer will alert the user about the imminent output power outage (in min).
- Internal battery: not available on this model.
- External battery: the external battery capacity (in Ah).

For the default settings see *Table 2* in the “Configuring the UPS from display” paragraph, *Table 3* in the “Default setting for other parameters” paragraph and *Table 4* in the “Default setting for output signals” paragraph.

MAIN SETUP PAGE



Tap the Main Setup icon to access the other configurations.



Main setup page

LANGUAGE SETTING



Enables the language configuration of the system menus.
Tap the flag to select the language.



Language configuration page

DISPLAY SETTING



Display configuration pages

To save any configuration setting:

Press the Save icon and confirm to store any new values.



Press return icon button to go back to the main setup page.



Save confirmation page

After pressing the save icon, confirm the overwriting of the new values into the system memory.

SYSTEM CLOCK

This page enables the user to configure the date and the time of the system.

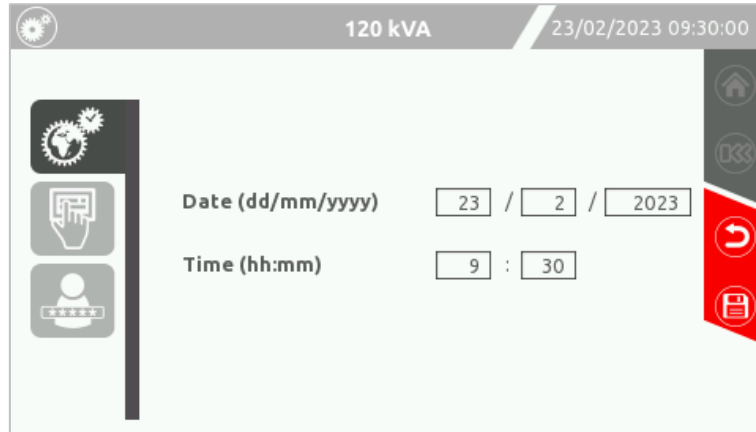

120 kVA 23/02/2023 09:30:00

Date (dd/mm/yyyy) 23 / 2 / 2023

Time (hh:mm) 9 : 30

System clock configuration page.

NOTE: When the system is first switched on or if the system has been switched off for a long period, it may be necessary to set date and time again.

SCREEN SAVER AND BUZZER

This page enables the user to:

- Define the display inactivity period to turn off the display backlight;
- Disable/enable the alarm buzzer. [Default → Buzzer ENABLED]



120 kVA 23/02/2023 09:30:00

Timeout homepage (min) [1-240] 10

Buzzer enabled

Screen saver and buzzer configuration page

NOTE: After the timeout the backlight of the screen will be turned off and the access level will be set as the higher non password-protected level. The touch screen pressure confirmation sound cannot be deactivated.

CHANGE PASSWORD

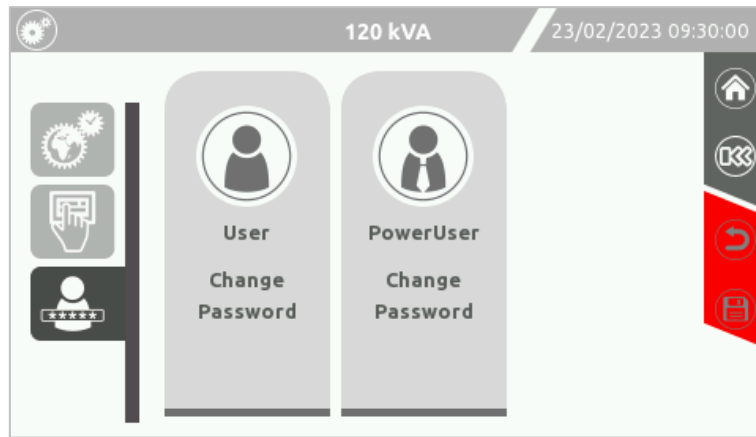

Access level selection page. For more information refer to the “Access users level” paragraph.

SYSTEM LOG PAGE



Tap the Event Log icon to access the system log.

In this page, the user can view the UPS event history.

The rise and fall indicate respectively when the alarm related to the event happened and when it was cleared.

Date/Time	Event Description	Status
22/02/23 10:30	[A25] Output switch open	Fall
22/02/23 10:30	[C04] Battery test active	Rise
22/02/23 10:30	[E13] Battery working	Rise
22/02/23 10:31	[E13] Battery working	Fall
22/02/23 10:31	[C04] Battery test active	Fall
22/02/23 10:31	[A25] Output switch open	Rise
22/02/23 10:33	[A25] Output switch open	Fall
22/02/23 10:34	[A25] Output switch open	Rise

System log page

By using the arrows, the user can scroll up and down through the event list.

The UPS will record the last 960 events occurred. The older ones are then overwritten.

“EXPERT” LEVEL

It is possible to access the “Expert” level in which the general UPS configurations are enabled. The “Expert” level is reserved only for trained personnel with knowledge of the UPS parameter configuration.



To access to the “Expert” level, expand the drop-down menu in the Home page and tap level selection icon. A password is required. Insert the preset password **expert** to access the “Expert” level.

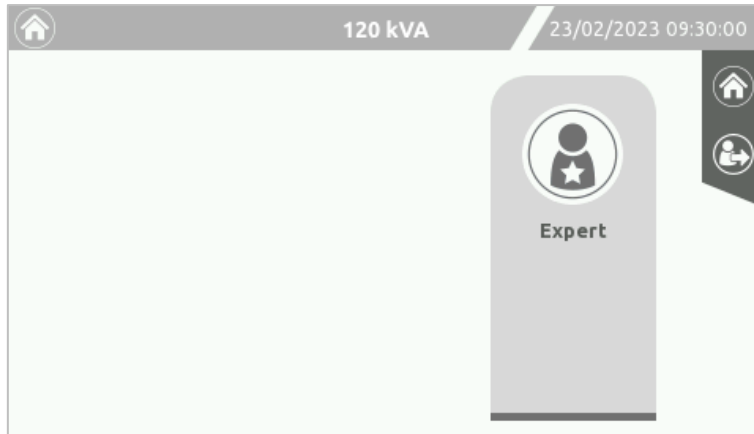

“Expert” level selection page



“Expert” password page

NOTE:

- 1) If the display goes into standby (backlight off) the access level will be changed to the higher non password-protected level.
- 2) The password may be different to the default setting if it has been previously configured (refer to the “Password change” paragraph).
- 3) To exit the password privileges, press the “Logout” icon (time out home page)



the “Expert” access level icon will appear in the drop-down menu

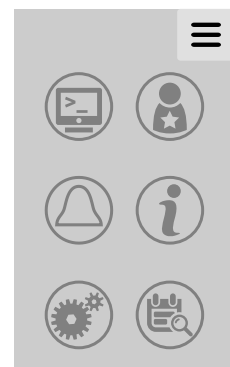

GENERAL SYSTEM SETTINGS

Only “Expert” level users can access this page. It enables additional system configuration.



With the “Expert” access level enabled, tap the Main Setup icon.



Main setup page in the “Expert” mode (with additional “General” icon)



General system settings pages

GENERAL CONFIGURATION

Enables various options for the UPS:

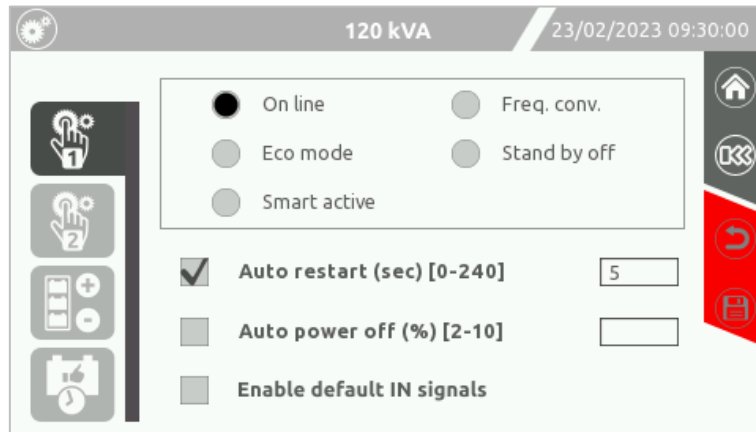

General configuration page 1: operating mode configuration

OPERATING MODE

The user can choose the operational mode (refer to the Chapter “Operating modes” for further details regarding these modes).

AUTO RESTART

The Autorestart function allows automatically UPS switches on when the mains power is restored, if during battery operation the system switches off due to the end of autonomy, by remote shutdown command or by Auto power off enabled. It remains in standby if the function is disabled [Default → Function ENABLED].

The user can specify how long the UPS will wait (after the mains supply restore) before turn on [Default → 5 sec].

If more than one unit is connected to the same supply, selecting a different time for each UPS will avoid any nuisance breaker trips due to excessive current absorption.

AUTO POWER OFF

If, during battery operation, the percentage of the load powered by the system falls below the selected threshold, after 40 seconds the system automatically switches off if the function is enabled; the system continues to function normally via battery if the function is disabled [Default → Function DISABLED].

ENABLE DEFAULT IN SIGNALS

The user can enable the default settings for programmable input signals. Refer to Table 4.2, “Setting for input signals (default configured from the display panel)” paragraph.

INVERTER OUTPUT SETTINGS

From this page, the user can set the output voltage of the inverter and the output frequency.

WARNING: These settings must be correctly configured by expert personnel only; improper settings can lead to severe damage of the load connected to the UPS output.

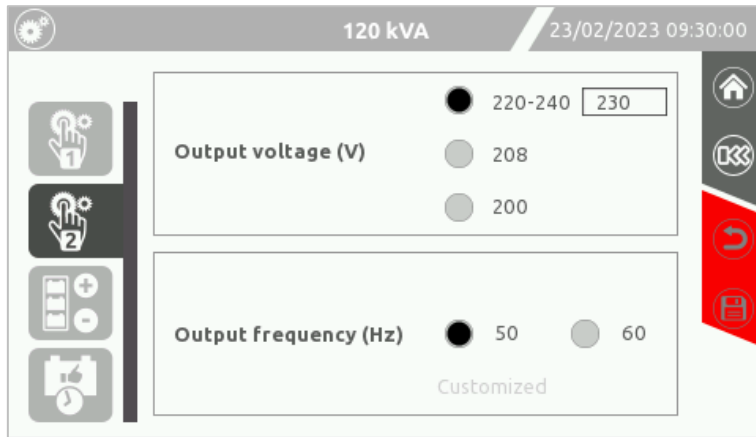

General configuration page 2: Output voltage and frequency setting

NOTE: by selecting a low output voltage (200, 208 and 220V), the output power will be consequently reduced. Refer to the graph below:

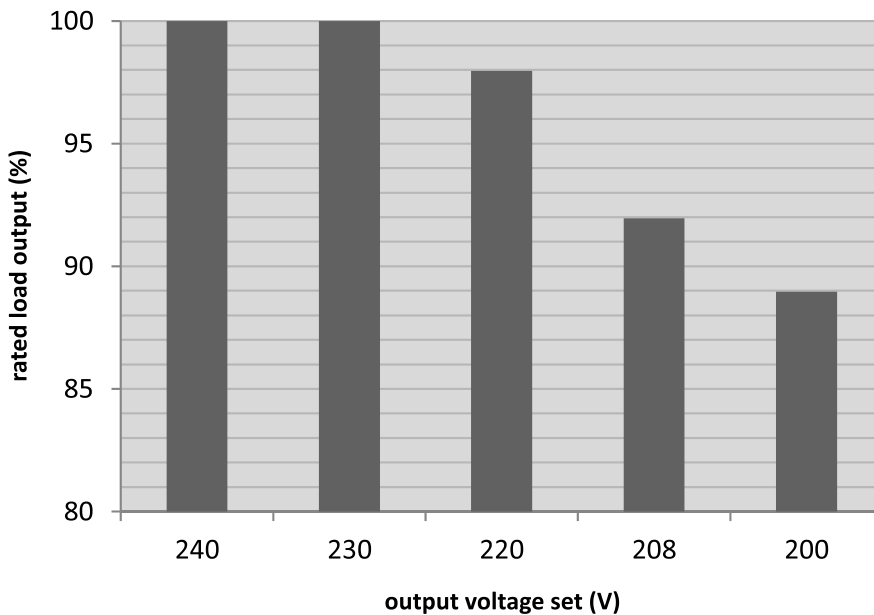

VOLTAGE SETTING

To set the desired output voltage, tap on the corresponding select box. The first selection is customisable by writing the voltage in the text box. If a low output voltage is selected, the percentage of power derating is shown on the right. The modification can be done also when the system is ON LINE.

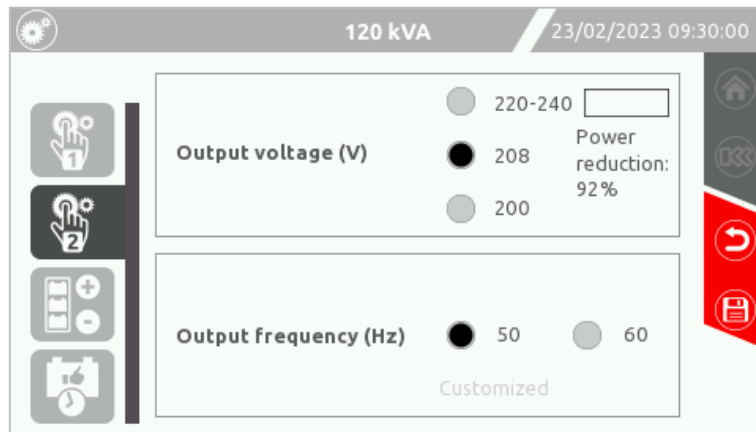

General configuration page 2: Percentage of power derating with low output voltage.

FREQUENCY SETTING

To set the desired output frequency, tap on the corresponding select box. Preset frequencies are 50 and 60 Hz. Custom output frequencies are set by using the service configuration software. If a custom output frequency is set the value can be read within the text box.

NOTE: The frequency setting is available only when the UPS is in stand-by or the output switch is open.

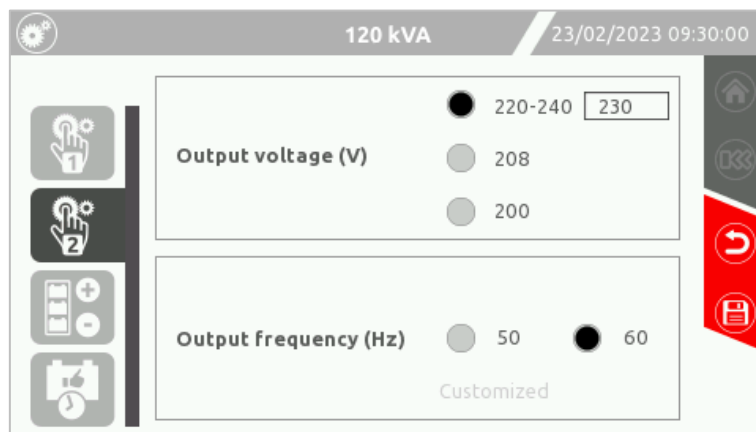

General configuration page 2: Output frequency configuration.

BATTERY CONFIGURATION

This page displays the battery capacity.

To set the battery capacity it is necessary to use the configuration software (reserved for service personnel only).



Battery capacity configuration page

BATTERY TEST SCHEDULING

S3T UPS are equipped with a built-in battery test function.

This page enables the user to schedule the automatic battery tests in order to regularly monitor the battery health.

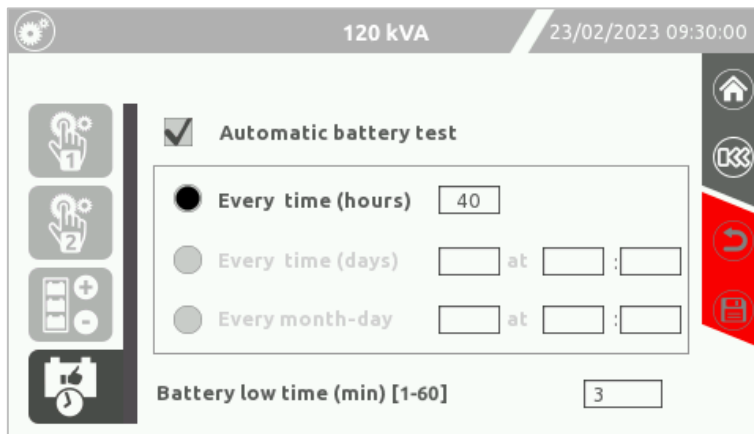

Battery testing configuration page

It is possible to schedule the battery test in three different ways:

- Every “n” hours: the UPS will start the battery test at regular intervals, not necessarily at the same time of the day.
- Every “n” days (in “n” days, at a certain hour): the UPS will start the test at regular intervals in the same hour of the day.
- Every month (at the selected day/hour): the UPS will start the battery test in the selected day of the month.

BATTERY LOW TIME

Set the estimated runtime (expressed in minutes between 1 and 60), below which the system displays the battery low alarm and the buzzer starts to beep.

[Default → 3 min].

ACCESS USERS LEVEL

It is possible to control access user levels, by setting a password for each one.



“User” level



“PowerUser” level



“Expert” level



To set or change a level password expand the drop-down menu  in the Home page and tap the Main Setup icon.



Select the display configuration and the password setting for each user. A password confirmation is required.

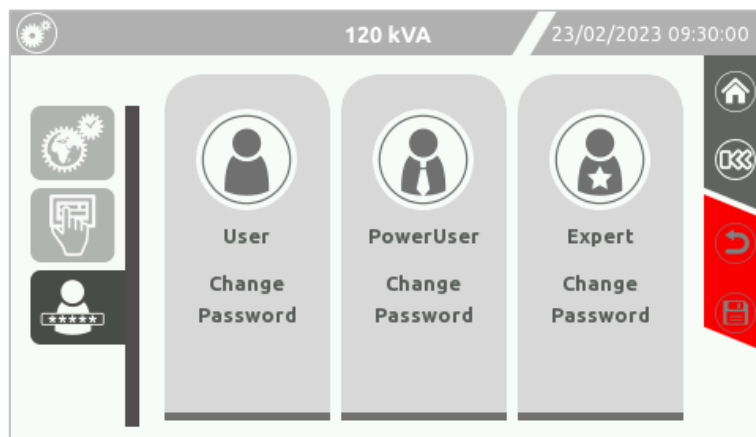

Display configuration page 3: User password configuration page

In addition, to the “Expert” level it is possible to create another two levels:

“POWERUSER” LEVEL



The “PowerUser” level allows the default commands and settings as provided by the factory configuration. All these available commands and settings are previously described.

Setting the “PowerUser” password prevents access to the “Command launcher”, “Settings menu” and “Event log” menu to unauthorised users.

“USER” LEVEL



“User” level allows only basic display actions. The menu in the home page is reduced to only these icons:



- Access level selection
- Buzzer toggle button
- UPS info

Setting the “User” password prevents access to any menu, except for the event alarm icon.

ACCESS LEVEL SELECTION

This page enables the selection of the access level for the user operating the UPS. If preset, a safety password may be requested, based on the selected level.



Expand the drop-down menu in the Home page and touch the access level selection icon.

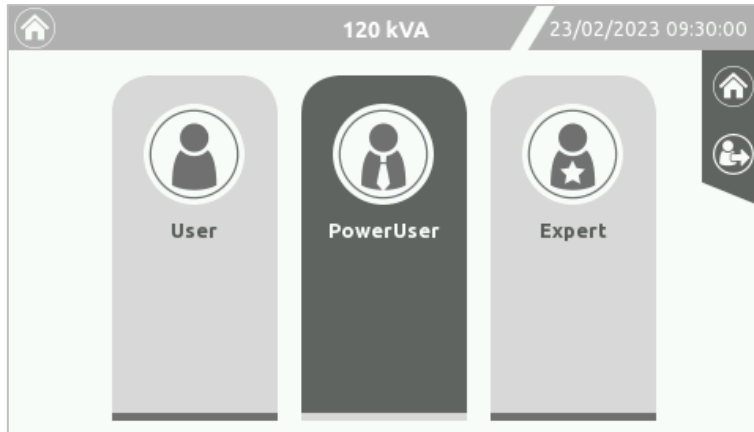

Access level selection page

If some of this icon is not visible, it means that the password protection is not set for this access level.

NOTE:

- If no password is configured for a given user-level, the functions relative to that access level are available to anyone.
- Password protection has to be configured from the higher user level.
- Access as “**Expert**” user to configure the system.
- The drop-down menu in the Home page may change based on the used access level.
- When a password protective level is activated a pre-set password permit to access the available command for that level.
- If the display goes in standby (backlight off) the access level will be raised to the higher non password-protected level.

PASSWORD CHANGE

Touch one of the three user icons matching the access level for which it is intended to set or change the password and type/change the password. The password will be required to be entered twice to ensure it is correct.

Entering a blank password will disable the password for that user.

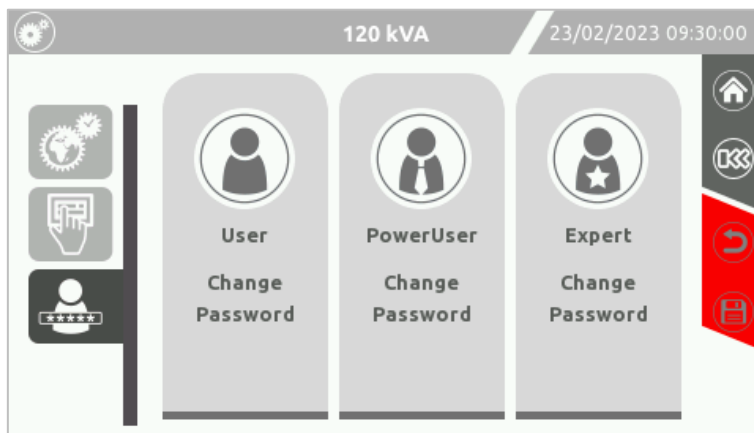

User password configuration page

WARNING:

If no password is configured for a given user-level, the function relative to that access level are available to anyone.



Pay attention not to forget the password. If the access level password is forgotten, it is impossible to access the specific operations for that level.

STATUS LED

Below the touch screen display, a back illuminated bar will inform the user at a glance the status of the UPS. The following are the various colour-states and their respective meanings.



Light blue (pulsing): Normal operation

No anomalies are present, and the system is working in the selected mode.



Dark blue: Bypass operation

The system is working from temporary bypass.



Orange: Anomaly

The system is working from battery, forced bypass or an anomaly or warning occurred. Refer to the "STATUS/ALARM CODES" section for detailed information about the status of the UPS.



Flashing red: Fault condition

A fault or lock occurred, or the load is not powered due to an unexpected condition (e.g. Emergency Power Off). Refer to the alarm page of the display for detailed information about the status of the UPS.

BUZZER

The UPS status and any anomalies are reported by a buzzer, which emits a modulated sound according to the various UPS operating conditions.

The different types of sound are described below:

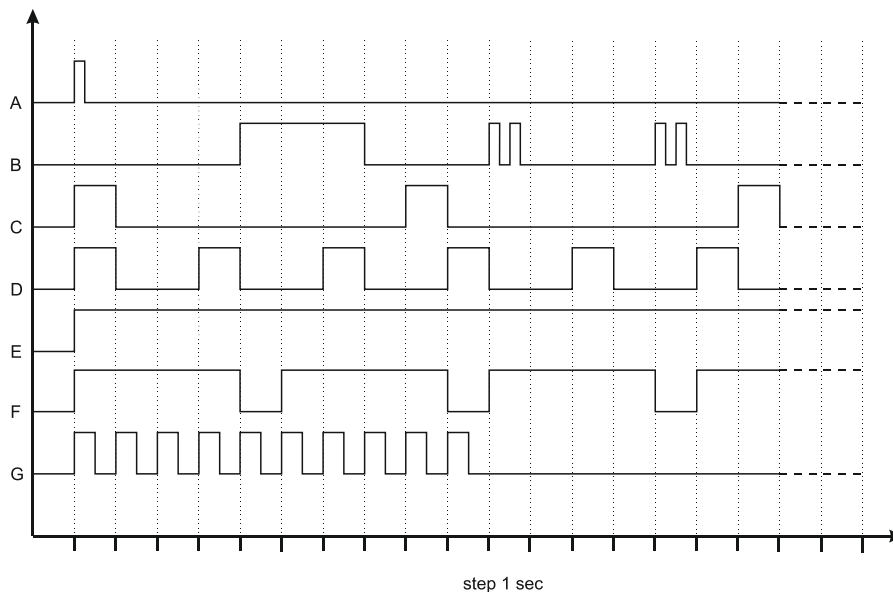

- Sound A: This sound is emitted to confirm any touch screen command.
- Sound B: This sound is emitted when the UPS switches to bypass.
- Sound C: This sound is emitted when the UPS switches to battery status. (When the battery end-of-discharge signal is given the buzzer sound change to pattern "D").
- Sound D: This sound is emitted when a generic alarm occurs (lock, fault, anomaly, warning).
- Sound E: This sound is emitted when there is an inverter lock or load off alarm.
- Sound F: This sound is emitted if a battery overvoltage fault occurs.
- Sound G: This sound is emitted in case of a battery test fault. The buzzer emits ten beeps. The alarm signal indicates the necessity to replace the battery or to perform a service on the UPS.

When an alarm is silenced, all the alarms with same sound are silenced, the buzzer is reactivated when an alarm with a different sound pattern appears.

CONFIGURING THE UPS FROM DISPLAY

Configurations which can be modified by the user from the display are listed in *Table 2* (below).

FUNCTION	DESCRIPTION	DEFAULT	POSSIBLE CONFIGURATIONS	ACCESS LEVEL
Language	Selection of the mimic panel language	English	<ul style="list-style-type: none"> • English • Italian • German • French • Spanish • Portuguese • Czech • Polish • Russian 	“PowerUser”
Homepage timeout	Selection of the screen saver timeout	5 min.	1-240 minutes	“PowerUser”
Buzzer	Disables the alarm buzzer	ON	<ul style="list-style-type: none"> • OFF • ON 	“PowerUser”
Date and time	UPS internal clock setup	-	-	“PowerUser”
Operating mode	Selection from among five different operating modes	ON LINE	<ul style="list-style-type: none"> • ON LINE • ECO • FREQUENCY CONVERTER • SMART ACTIVE • STAND-BY OFF 	“Expert”
Battery low	Estimated autonomy time remaining for “battery low” warning	3 min.	1-60 @ 1 min step	“Expert”
Auto Restart	Enables the auto restart function	5 sec.	<ul style="list-style-type: none"> • OFF • ON (configurable 0-240 seconds) 	“Expert”
Auto Power Off	Enables and configures the auto power off function	OFF	<ul style="list-style-type: none"> • OFF • ON (configurable 2-10%) 	“Expert”
Output voltage	Selection of the output voltage (Phase - Neutral)	230V	<ul style="list-style-type: none"> • 220-240V (custom) • 208V • 200V 	“Expert”
Output frequency	Selection of the inverter frequency	50Hz	<ul style="list-style-type: none"> • 50Hz • 60Hz 	“Expert”
Automatic battery test	Enables and schedules the automatic battery test	40 h	<ul style="list-style-type: none"> • OFF • ON (programmable) 	“Expert”
User password change	Replacement of the current password with a new one	-	Any combination of characters for a maximum of 16	“User”
“PowerUser” password change	Replacement of the current password with a new one	-	Any combination of characters for a maximum of 16	“PowerUser”
“Expert” password change	Replacement of the current password with a new one	expert	Any combination of characters for a maximum of 16	“Expert”

Table 2 – UPS configuration (available from display)

DEFAULT SETTING FOR OTHER PARAMETERS

In the *Table 3* (below) is listed the default setting for other parameters.

FUNCTION	DESCRIPTION	DEFAULT	POSSIBLE CONFIGURATIONS
Power Walk-In Delay	Delay time of the UPS Power Walk-In	3 sec.	0 - 120 seconds
Power Walk-In Duration	The duration of the transition mode	Disabled	1 - 120 seconds
Stand-by off Delay	Delay between the mains comeback and the output UPS switching off	0 sec.	0 - 3600 seconds

Table 3 – Default settings for other parameters (not available from display)

DEFAULT CONFIGURATION OF THE INPUT/OUTPUT SIGNALS

OUTPUT SIGNALS CONFIGURATION (FACTORY DEFAULT)

Table 4 (below) lists the default configuration of the output signals.

OUTPUT	FUNCTION	DESCRIPTION
OUT 1	Load on Bypass	<ul style="list-style-type: none"> ▪ Load on bypass with closed contact between pin 2 and pin 4; ▪ Otherwise closed contact between pin 1 and pin 4.
OUT 2	Battery working	UPS in battery working with closed contact between pin 3 and pin 4.
OUT 3	Battery low	<ul style="list-style-type: none"> ▪ Battery low with closed contact between pin 8 and pin 6; ▪ Otherwise closed contact between pin 8 and pin 5.
OUT 4	Fault or Lock (F+L)	Fault or lock alarm with closed contact between pin 7 and pin 8.

Table 4 – Default configuration for output signals

INPUT SIGNALS CONFIGURATION (FACTORY DEFAULT)

Table 4.1 (below) lists the default configuration of the programmable input signals as provided for factory default setting.

INPUT	FUNCTION	DESCRIPTION
IN 1	-	-
IN 2	-	-
IN 3	-	-
IN 4	-	-
IN 5	System ON	By externally connecting pin 5 and pin 6 with normally open contact, when it is closed the UPS switching on.

Table 4.1 – Configuration of input signal in factory default

INPUT SIGNALS CONFIGURATION (DEFAULT CONFIGURED FROM THE DISPLAY PANEL)

Table 4.2 (below) lists the default configuration of the programmable input signals which can be configured from the display panel.

INPUT	FUNCTION	DESCRIPTION
IN 1	Position of the External SWMB	<p>Indication of External Manual Bypass Switch position via the auxiliary contact (auxiliary contact of the external manual bypass switch). Connect pin 1 and 6 together via an external normally closed contact.</p> <p>CONTACT CLOSED → SWMB OPEN CONTACT OPEN → SWMB CLOSED</p> <p>When the connection is opened the UPS will receive a manual bypass command.</p>
IN 2	Position of the External SWOUT	<p>Indication of External Output Switch position via the auxiliary contact (auxiliary contact of the external output switch). Connect pin 2 and 6 together via an external normally open contact.</p> <p>CONTACT CLOSED → SWOUT CLOSED CONTACT OPEN → SWOUT OPEN</p> <p>The UPS will receive information in relation to the status of the external output switch.</p>
IN 3	CB OFF	By connecting pins 3 and 6 to a normally open contact, when the contact is closed the UPS battery charger is disabled.
IN 4	Bypass ON	By connecting pins 4 and 6 to a normally open contact, when the contact is closed the UPS will switch to bypass mode.
IN 5	System ON	By connecting pins 5 and 6 to a normally open contact, when the contact is closed the UPS will switch on.

Table 4.2 – Default configuration of the input signals which can be configured from the display panel

OPERATIVE PROCEDURES

PRELIMINARY OPERATIONS

Before powering the UPS and starting the operative procedures, in order to avoid any system damage, follow the operations below.

- **Visual check of the connection**
 - Check that all the isolators are open.
 - Check that all the connections have been made strictly following the indications given in the "Installation manual".
- **Before connecting the load** to the UPS and starting the operative procedures, in order to avoid any system damage, and to check that there is no errors within the installation downstream of the UPS, follow the below steps:
 - Close SWMB.**
 - Close the protective devices upstream to the UPS.
 - Verify there isn't an output short circuit in the wiring system.
 - Open the protective devices upstream to the UPS.
 - Open SWMB.**
- **Close the protective devices upstream to the UPS.**



Before any attempt to turn the system on, it is mandatory to check the power supply and connection of phase, neutral and external battery wires.

To connect the Battery Cabinet, insert in the battery fuse holders the relative fuses contained in the accessories box

Refer to the Installation manual.







WARNING: In order to isolate the UPS from all of the DC sources, disconnect all Battery cabinets, if present.

NOTE: When the fuses are closed, a small arc flash may occur due to the charge of the capacitors present inside the UPS. This is normal and does not cause faults and/or damage.

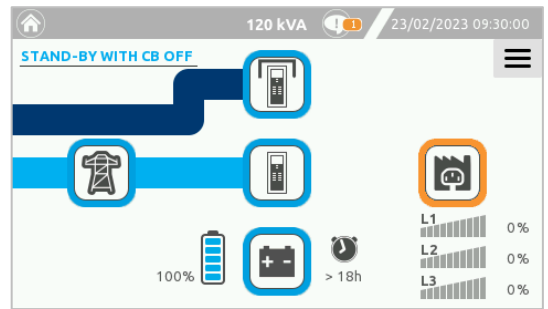
SYSTEM ON DIRECT COMMAND

- Close the mains input switch (SWIN), the bypass input switch (SWBYP) if present, and the battery fuse holder (SWBATT) of the Battery Cabinet.
- Check that the display turns on and the UPS enters into the "STAND-BY WITH CB OFF" mode.
- Verify that the Mains and the Bypass input voltages on the "System measurements" page are present.
- Check that no error messages appear (except "Output Switch open").



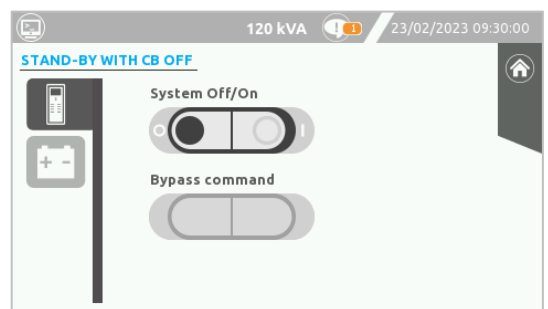

- Press the "Menu" icon  and select the "Command launcher" icon .
- Tap the "SYSTEM ON" command and press OK to confirm.
- Wait for a few seconds and check that the UPS turns on with the output powered by the inverter. The buzzer should start and the system status should read DISCONNECTED FROM THE LOAD. This indicates that the output switch (SWOUT) is not closed and the load is not supplied.
- From the  menu select the "bell" icon  if you want to silence the alarm.

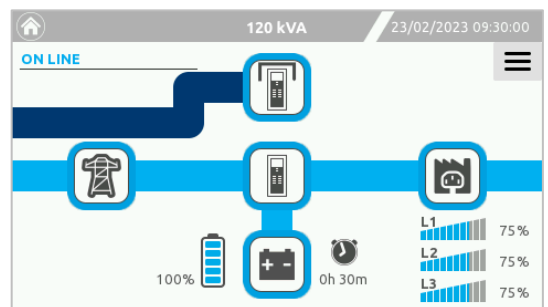

- Close the Output switch to supply the load and check that the inverter is correctly powering it.
- Verify on the home page that system operating mode is "ON LINE".
- Check the Output parameters in the Output status page.
- Check the battery status (if present) and verify the measurements.



- Set the Date and Time,
- Enter the "General and System setting" menu .
- Tap the "Display" icon  and set the desired value in the Date/Time page.
- Store the new settings by pressing the "Save" icon.
- In order to return to the main page, press the "HOME" icon.

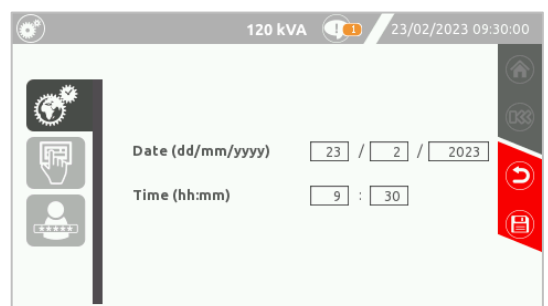

SYSTEM ON COMMAND VIA BATTERY (COLD START)

For the COLD START button location, please refer to the “General views” chapter.

Note: Avoid turning on the system from battery if the battery charge status and/or the autonomy information are unknown.

- Close the battery fuse holders of the Battery Cabinet.
- Press the “cold start” button and keep it pressed for at least 5 seconds.
- The system will turn on in the “STAND-BY WITH CB OFF” mode (The status led will light up and the display will start).

NOTE: if no actions are taken within one minute, the system will automatically shut down to avoid discharging the batteries.

- Verify that no anomalies are present on the status bar (except for the anomalies referring to the absence of input and bypass mains and the “Output Switch open”).
- From the “Command Panel” page, press the “System ON” icon to start the System.
- Confirm the “SYSTEM ON Command”, by selecting OK. The UPS will turn on.
- If the battery measurements are ok and no anomalies are present except “Output Switch open” (the system will be in the “DISCONNECTED FROM LOAD” state), close the SWOUT output switch.
- Verify the output voltages on the Output status page.
- The system is now in the BATTERY WORKING mode.
- To restore the UPS to On Line mode, close the input (SWIN) and bypass input (SWBYP) switches with mains present. The UPS will change to ON LINE mode and the batteries will begin to charge.

OPERATIONS CHECKS

Follow the procedures below to verify that the UPS works properly during battery working and automatic bypass switching. These operations must be executed with the UPS in ON LINE mode.

BATTERY TEST

- Press the “Battery Test” icon to execute the command. A confirmation is required.
- Wait until the procedure has been completed. Only if the battery test result gives no anomalies, continue with the Battery Working check.

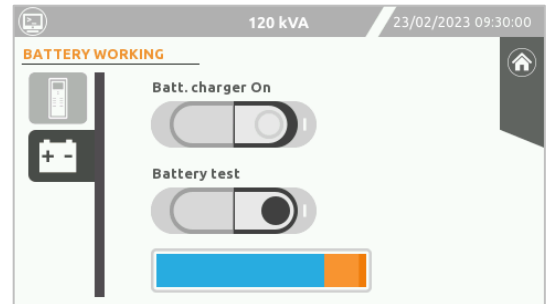

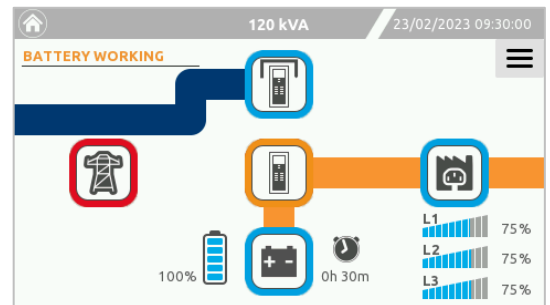

BATTERY WORKING

- Open the input switch (SWIN) and wait for a few seconds.
- Check that the UPS goes into Battery Working status and that the output voltage remains present and stable by checking the system output page.
- The buzzer should start to inform the user that the UPS is running from battery.



LOAD FORCED ON BYPASS

- Press the “Menu” icon  and select the “Command launcher” icon .
- Press the “Bypass command” (1) icon to switch the system into static bypass. A confirmation is required.
- Check that the UPS status changes to “LOAD FORCED ON BYPASS” and that the output voltage is still present and stable by checking the system output page.
- The buzzer should start to inform the user that the UPS is in Load Forced on Bypass mode.
- Press “Bypass command” (0) icon to switch the system back to ON LINE mode. A confirmation is required.

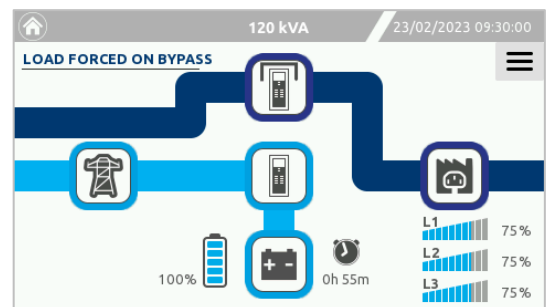

SWITCHING THE SYSTEM FROM ON-LINE TO MANUAL BYPASS

The following operations have to be performed in order to switch the UPS load to “Manual Bypass”.

NOTE: if the Bypass line is not present, the manual bypass operation will cut off power to the load.

With the SWMB closed, the load is supplied directly from the bypass line.

The switching of the System to manual bypass can be done following this procedure:

VIA STATIC BYPASS (to ensure the best protection to the load):

- Verify that no anomalies are present on the system status bar.
- Verify that the bypass voltages are correct on the “System measurements” page (no presence of the message “Bypass not available”).
- Verify that the inverter is synchronized to the bypass line (no presence of the message “Inverter asynchronous”).
- From the “Command Panel” page, tap the icon “Bypass command” button to switch the system to static bypass.
- Confirm “BYPASS ON Command”.
- Verify that the system switches to “LOAD FORCED ON BYPASS”.
- Close the SWMB switch.
- The load is now supplied directly by the bypass line through the manual bypass switch.
- From the “Command Panel” page, press the “System OFF” icon to switch the system off.

NOTE:

1. In case of an installation with external SWMB switch, verify first the proper connection of the respective Auxiliary Contact.
2. If the UPS is in battery mode, activating the maintenance bypass will shut off the power supply to the load.
3. During this phase, with a load powered via the maintenance bypass, any disturbances on the mains power supply line of the UPS will directly affect the connected load (The load is connected directly to the incoming mains. The UPS is no longer active).

Below is a list of the operations to be performed in order to carry out maintenance work on the equipment without shutting off the power supply to the connected load:



WARNING: Maintenance works inside the UPS are to be performed exclusively by qualified staff.

- Open the input switches (SWIN and SWBYP), output switches (SWOUT), battery fuse holder (SWBATT) and all external Battery Cabinet switches if any external batteries are present. The display panel will turn off. Wait for a minimum of 15 minutes in order to allow the electrolytic capacitors on the power board to completely discharge and then perform the maintenance operations.
- Having completed the maintenance operations, proceed to restart the UPS following the correct procedure.

EMERGENCY MANUAL BYPASS PROCEDURE

Quick procedure not recommended for external maintenance bypass operation or in case of anomalies on the bypass line.

- Verify that the bypass voltages are correct on the “System measurements” page.
- Verify that the inverter is synchronized to the bypass line (no presence of the messages “Bypass not available” or “Synchronisation disabled”).
- Close the SWMB manual bypass switch: the bypass line will now be directly supplying the connected load.

RESTORE THE ON LINE MODE AFTER MANUAL BYPASS

The following operations have to be performed in order to switch the UPS from “Manual Bypass” to ON LINE mode:

- Switch on the Mains (SWIN), the Bypass (SWBYP) and Battery input lines (SWBATT) of the Battery Cabinet and close the Output switch (SWOUT).
- The system will turn on in "STAND-BY WITH CB OFF" mode (The status led will light up and the display will start).
- Verify that the Mains and the Bypass input voltages are present on the “System measurements” page.
- Verify that no anomalies are present on the status bar (except [C05] “Manual bypass command”).
- From the “Command Panel” page, press the “System ON” icon to start the system.
- Confirm the “System ON Command”, by selecting OK. To ensure that the system is in static bypass mode, verify that the system is in “MANUAL BYPASS ACTIVE”. In this case the bypass line is represented with a blue filled line as indicated in the following image.

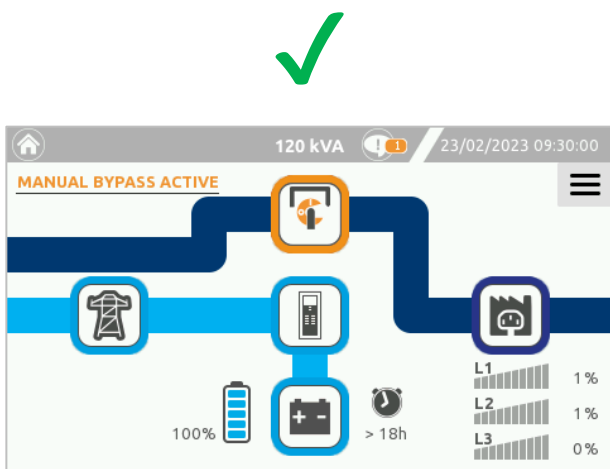

The bypass line is represented with a filled blue line. In this condition, it is possible to open the manual bypass switch.

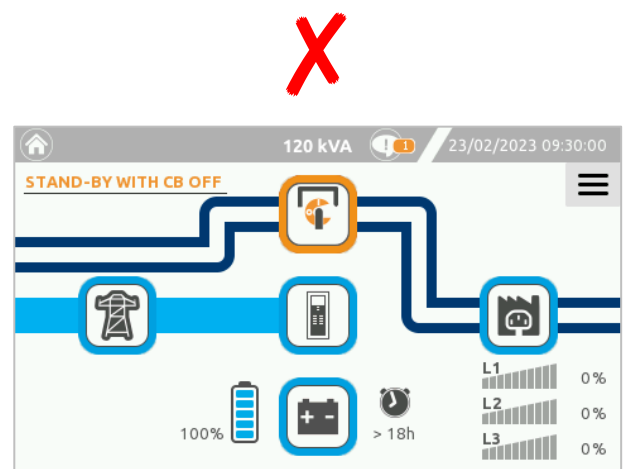

The bypass line is represented with a white stripe. In this condition, do not open the manual bypass switch: the load will be lost.

- Verify the output voltages on the “System measurements” page and verify that no anomalies are present on the status bar.
- Check the status of the batteries (if present) and verify the measurements.
- If the “SYSTEM ON” command is activated properly, all measurements will be ok and no anomalies will be present, open the Manual bypass switch (SWMB).
- Verify that the system status changes to “ON LINE” mode.
- Now the system is On Line.

NOTE: if the bypass line is represented with a white stripe, it means that the load is supplied by the manual bypass alone. If the manual bypass switch is opened in this condition, the power to the load will be lost. The system is off.

LOAD ON STATIC BYPASS AFTER MANUAL BYPASS

The following operations are to be performed in order to switch the UPS from “Manual Bypass” to “Load forced on bypass” status:

- Switch on the Mains (SWIN), Bypass (SWBYP) and battery input lines (SWBATT) of the Battery Cabinet and close the output switch (SWOUT).
- The system will turn on in "STAND-BY WITH CB OFF" mode (The status led will light up and the display will start).
- Verify the Mains and Bypass input voltages on the “System measurements” page.
- Verify that no anomalies are present on the status bar (except [C05] “Manual bypass command”).
- From the “Command Panel” page, press the “System ON” icon to start the system.
- Confirm “System ON Command”, by selecting OK. To ensure that the system is in static bypass mode, verify that the system is in “MANUAL BYPASS ACTIVE”. In this case the bypass line is represented with a blue strip as in the following image.

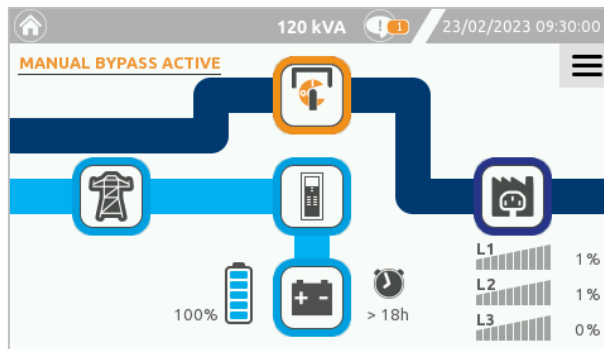

- From the “Command Panel” page, tap the icon “Bypass command” button to switch the system to static bypass.
- Confirm “BYPASS ON Command”.
- Verify that the system status changes to “LOAD FORCED ON BYPASS” in a few seconds.
- Verify the output voltages on the “System measurements” page and verify that no anomalies are present on the status bar.
- Check the status of the batteries (if present) and verify the measurements.
- If all measurements are ok, no anomalies are present and the bypass command is activated, open the Manual bypass switch (SWMB).
- Verify that the system status changes to “LOAD FORCED ON BYPASS”.

SYSTEM OFF COMMAND

- From the “Command Panel” page, press the “System ON/OFF” icon to switch the System off.
- Confirm “System OFF Command”, by selecting OK.



NOTE: during prolonged periods of inactivity, it is good practice to shut down the UPS; open the input and output switches (after system off) and lastly, with the UPS off, open the battery fuse holder (SWBATT) of the Battery Cabinet to avoid unnecessary battery discharge.

When the UPS is started again, it is possible that date and time will need to be manually restored.

POWER OFF THE UPS WITHOUT ACCESS TO THE DISPLAY

- Open SWOUT. The buzzer should start to inform the user that the output switch (SWOUT) is open and thus the load is not supplied.
- Open then SWBATT of the Battery Cabinet, SWIN and SWBYP (if present).

EXTERNAL BATTERY CABINET

All the UPS within the S3T family can be supplied with matching external Battery Cabinets. These can be supplied by the factory or by a local supplier subject to being compliant with the statement below.



Read the Battery Cabinet manual before connecting the batteries.



The Battery Cabinet total voltage shall meet the requirements of the UPS (refer to the Battery Cabinet nameplate and/or Battery Cabinet User Manual).



THE CONNECTION BETWEEN THE UPS AND THE BATTERY CABINET MUST BE MADE WITH THE UPS POWERED OFF AND ISOLATED FROM THE INCOMING MAINS SUPPLY

UPS POWER-OFF PROCEDURE:

- Please Refer to the "Operative Procedures", "System off command" paragraph.
- Open all the isolation switches of the UPS.
- Isolate the UPS from the incoming mains power supply by opening all the external protective devices situated on the input and output lines.
- Wait a few minutes before proceeding to work on the UPS.
- Remove the terminal cover from the UPS.

CONNECTING THE BATTERY CABINET:



ATTENTION: For the cross sectional area of the connection cables please refer to the "Installation Manual", "POWER CONNECTION INFORMATION" paragraph. Furthermore, the three battery cables (+, -, N) must be placed close to each other in order to avoid loops.



For EMI reasons, if possible, place the UPS and Battery Cabinet side by side in order to keep the cable length as short as possible (suggested 3mt maximum). If it is not possible due to space limitations, maximum admitted length is 25mt. If extended length is required, please contact your local service centre.

- Check that the battery voltage of the Battery Cabinet corresponds to that allowed by the UPS (check the data plate on the Battery Cabinet and the UPS manual)
- **IMPORTANT:** make sure that the fuse holders of the Battery Cabinet are open.
- Remove the terminal cover from the Battery Cabinet.
- Connect the earthing terminals of the UPS and Battery Cabinet using a yellow/green wire of the proper cross section.
- Connect the wires to the terminals of the UPS and the Battery Cabinet:
 - terminals marked with the + symbol with the red cable (or colour as stipulated by local/country regulations)
 - terminals marked with the N symbol with the blue cable (or colour as stipulated by local/country regulations)
 - terminals marked with the - symbol with the black cable (or colour as stipulated by local/country regulations)

The correspondence indicated by the symbols printed on the terminal cover of the Battery Cabinet and the UPS must be respected.

Please refer to the Installation manual for further information with regards to the wiring cross sectional area.

- Replace all of the terminal covers previously removed.

CHECKING INSTALLATION:

NOTE: the size of the fuses fitted will depend on the type of Battery Cabinet installed. If the Battery Cabinet is supplied by our Company, make sure to have the correct fuse for the given UPS size (refer to Battery Cabinet manual).

In case the Battery Cabinet isn't supplied by the factory, please check that a DC switch is provided and that correct fuses are installed according to *Table 5*. In any case, please read all the documentation provided by the supplier and check carefully the compatibility with the UPS (voltage, number of poles, polarity etc.). Neutral wire must be connected. During maintenance operations the Battery Cabinet switch must be open in order to isolate it from the UPS.

- Insert the right fuses (see *Table 5* below) in the SWBATT fuse holders of the Battery Cabinet.

UPS (kVA)	Type of fuse	Current rating of battery protection device [A]
80	gR or gS	2.5 x the battery capacity in Ah up to max 200A (voltage 500Vdc)
100	gR or gS	2.5 x the battery capacity in Ah up to max 250A (voltage 500Vdc)
120	gR or gS	2.5 x the battery capacity in Ah up to: max 250A for capacity ≤ 120Ah (voltage 500Vdc) max 300A for capacity > 120Ah (voltage 500Vdc)

Table 5 – UPS battery protection devices

- Close the SWBATT fuse holders of the Battery Cabinet
- Carry out the UPS power-on procedure described in the USER MANUAL.
- Once the UPS is started, check that the UPS is working properly: simulate a black-out by opening the SWIN input disconnect switch of the UPS. The load must continue to be powered, the status light must change to orange and the buzzer will beep at regular intervals. When the SWIN (input disconnect switch) is closed again, the UPS must return to normal operation from the mains supply within a few seconds.

BATTERY ROOM VENTILATION

The room where the Battery Cabinet is located must have sufficient ventilation to ensure the concentration of hydrogen produced is within safe limits.

The room should preferably be ventilated naturally; if it cannot be, forced ventilation may be employed.

Standard EN 62485-2 regarding air exchange provides that the minimum aperture must satisfy the following equation:

$A = 28 \times Q = 28 \times 0.05 \times n \times I_{gas} \times C10 (1/10^3) [cm^2]$ where:

A = area of opening [cm^2]

Q = airflow required [m^3/h]

n = number of battery cells;

$C10$ = battery capacity in 10 hours [Ah]

I_{gas} = gas producing current [mA/Ah]

according to the standard:

$I_{gas} = 1$ in backup charging for VRLA type batteries

$I_{gas} = 8$ in fast charging for VRLA type batteries

SETTING THE RATED BATTERY CAPACITY – SOFTWARE CONFIGURATION

Having installed one or more BATTERY CABINETS, the UPS must be configured to the rated capacity value (total Ah of external batteries).

To perform this operation, use the dedicated configuration software (reserved to service personnel only).

EXTERNAL BATTERY TEMPERATURE PROBE

An optional temperature probe kit provides the S3T UPS with the ability to monitor the temperature within a separate Battery Cabinet via the terminals located on the power terminal area, identified as “EXT T_BATT” (marked as 3 and 4, refer to the “Power connection details” paragraph of the Installation manual for further information).

This **non-isolated** input can be used also to adjust the battery voltage in accordance with the ambient temperature (temperature compensation) this feature must be enabled and configured via the configuration software (reserved to service personnel only). When the probe is configured, the Ext-Bat value will be shown on the “Sensor status” page.



It is essential that only the kit provided by the manufacturer is used. The use of a temperature probe that does not comply with the specifications may cause faults or failure of the equipment. Only authorised personnel can install and activate the temperature probe.

The kit enables the connection of a temperature probe for a Battery Cabinet placed adjacent to the UPS or up to 10 meters away. If this distance is insufficient then it is possible to extend it up to 25 meters.

To install the External Battery Temperature probe within the Battery Cabinet, refer to the manual provided with the kit.

EXTENDED RUN-TIME

An option is available for an Extended Run-time version (ER) where the maximum charging current can be increased as follows:

UPS (kVA)	Standard charging current [A]	ER charging current [A]
80-100	12	30
120	30	N.A.

Table 6 – Extended runtime charging current

This option is available as a factory fitted option.

DUAL INPUT

**AVAILABLE AS A FACTORY FITTED OPTION OR BY PURCHASING IT AS A RETROFIT KIT.
THE DI (OPTIONAL) VERSION OF THE UPS SERIES HAS BYPASS INPUT AND MAINS INPUT LINES SEPARATED.**

The UPS series with DI (separate Bypass) ensures a separate connection between the input and bypass lines. This option is available as a factory fitted option or by purchasing it as a retrofit kit (which can be installed by authorised service personnel only). In this case, for further details, refer to the Installation manual provided with the kit.

REMOTE MAINTENANCE BYPASS

An additional maintenance bypass may be installed within (or in addition to) the main switchboard, for example, to enable the UPS to be replaced without interrupting the power supply to the load, in this case respect the following details:



It is mandatory to connect the "SERVICE BYPASS" terminal (see the "Installation Manual", "Programmable IN – OUT signals" paragraph) to the NC auxiliary contact of the SERVICE BYPASS switch. Closing the SERVICE BYPASS switch opens this auxiliary contact which informs the UPS that the maintenance bypass has been activated. If this connection is not present, the power supply to the load may be switched off and the UPS damaged.

NOTE: Use cables with a cross sectional area that conforms to the indications given in "POWER CONNECTION INFORMATION" paragraph of the Installation manual.
Use a double insulated cable with a cross section of 1mm² to connect the "SERVICE BYPASS" terminal to the auxiliary contact of the remote maintenance bypass disconnect switch.



Whenever the UPS is equipped with an internal isolation transformer, check the compatibility between the "remote maintenance bypass" and the neutral arrangement within the electrical installation.

DIAGRAM SHOWING REMOTE INSTALLATION OF THE MAINTENANCE BYPASS

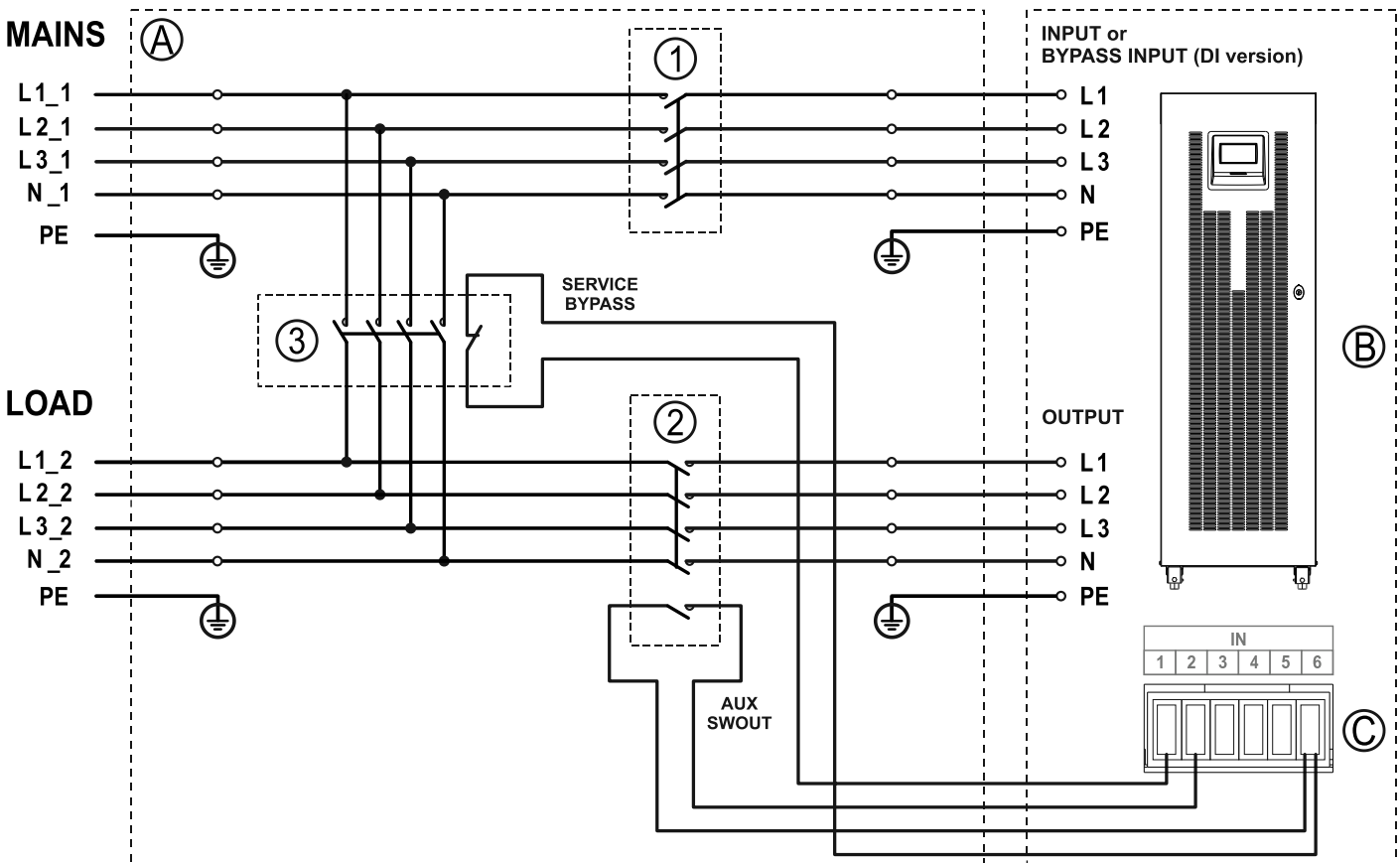

- (A)** Main switchboard
- (B)** Internal connections of the UPS
- (C)** Programmable IN/OUT port (to be configured via the configuration software)
- (1)** INPUT switch: for correct sizing refer to the "Internal Protective Devices" paragraph
- (2)** OUTPUT switch: for correct sizing refer to the "Internal Protective Devices" paragraph, equipped with a normally opened auxiliary contact
- (3)** SERVICE BYPASS switch: for correct sizing refer to the "Internal Protective Devices" paragraph, equipped with a normally closed auxiliary contact

EXTERNAL SYNC KIT

In order to synchronise the inverter output to an external source, a synchronisation kit is available. This kit contains an isolated single-phase low voltage output transformer (SELV).

Connect the transformer secondary to the "EXT SYNC" terminal block (marked as 1 and 2) in the power connections area (refer to the "Power connection details" paragraph of the Installation manual for further information) using a double insulated cable with a 1mmsq cross-section.

Make sure the polarity is respected as shown in the figure.

After installation, enable the control using the configuration software.

For EMI issues, keep the cable length as short as possible (suggested 25 mt maximum). If extended length is required, please contact your local service centre.

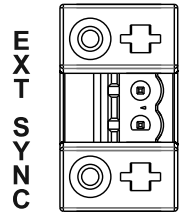

SUPERCAPACITOR VERSION

This configuration, provides the UPS with external supercapacitors instead of conventional battery as backup power.

ATTENTION! S3T Supercapacitor version can not operate with associated any type of batteries.

The UPS version with supercapacitors will not display the autonomy time. Furthermore the battery test command (and scheduling) together with START function will not be available.

Please refer to Supercaps cabinet manual to properly install and operate the system.

ENERGYMANAGER FOR LI-ION BATTERIES

This optional card must be used when the UPS is connected to the BMS (Battery Monitoring System) of a Li-Ion battery system which has been approved by our Company, please refer to the specific user manual of this card for the full list.

The EnergyManager includes two ports:

- Ethernet port 10/100 Mbps (RJ45 connector)
- RS485 serial port (RJ12 connector)

The two ports can be utilised depending on the battery type to communicate with the BMS of the battery cabinet, as described within the specific user manual.

REMOTE PANEL

The remote panel enables the remote monitoring of the UPS and gives a real time detailed summary of the machine status. The device ensures that the operator can monitor the electrical values of the mains power, outputs, batteries, etc. and locate any alarm conditions.

For further information regarding the connection and use of this device, please refer to its dedicated user manual.



PARALLEL

All S3T UPS can be paralleled with other units of the same size through an optional parallel board, to be inserted within the dedicated slot. It is possible to join in parallel up to eight three-phase units. For further information about the parallel feature, please refer to the relative "Parallel kit" user manual.



OPTIONAL SLOT BOARDS

The UPS is equipped with two expansion slots for accessory communication or I/O expansion boards that enable the equipment to communicate using the main communication standards.

Some examples:

- Second RS232 port
- Serial duplicator
- Ethernet agent with TCP-IP, HTTP and SNMP protocol
- RS232 + RS485 port with JBUS / MODBUS protocol
- Additional digital inputs
- Additional output dry contacts

For further information on the available accessories, refer to the latest catalogue or visit the web site.

FRONT DOOR AIR FILTER

An on-site installation special door is available as a kit with special dust filtering on this UPS series. This kit is designed for UPS located within a dusty environment.

The adding of the filter, if correct maintenance works are carried out, does not reduce the performance of the UPS (No power derating).



Regularly clean the air filter according to the environmental conditions.

IP30 VERSION

This option, available upon request, provides the UPS with a degree of protection up to IP30.

IPX1 KIT

S3T series can be equipped with an on-site installation kit for an optional roof, to protect the UPS against vertical falling drops of water. This kit is suitable for standard chassis (to achieve IP21 protection degree) or for IP30 version (to achieve IP31 protection degree).

SEISMIC KIT

With a specific kit, S3T is modified to operate in seismic activity installations according to ICC ES AC 156, SDS = 1.45 g for z/h=1.

Further details are available in the dedicated documentation.

For the complete list of compatible units, please refer to the price list.

STATUS / ALARM CODES

Using a sophisticated self-diagnostic system, the UPS can check and indicate on the display its status and any errors and/or faults that have occurred during its operation. When a problem arises, the UPS signals the event by showing the code and corresponding type of alarm on the display.

STATUSES

These codes indicate the current UPS status.

CODE	DESCRIPTION
S06	Stand-by mode with CB off
S07	Lock stand-by and CB off
S10	Precharge
S11	Precharge from battery
S20	Power off active
S21	Stand-by with CB on
S30	Wait recharge batteries
S31	Calibration
S32	Starting
S40	ON LINE mode
S41	ON LINE / Saving mode
S42	Economy mode
S43	Economy plus mode
S44	Active economy mode
S45	Frequency converter mode
S46	Frequency converter / Saving mode
S47	Ready for emergency
S50	Battery Working
S51	Battery Working forced
S52	Battery low
S60	Temporary bypass
S61	On bypass due to inverter lock
S62	Load forced on bypass
S63	Remote bypass command
S64	Manual bypass active
S65	On bypass due to battery ended
S70	Temporary inverter
S71	On inverter due to bypass lock
S72	Load forced on inverter
S80	Power circulation
S81	Power circulation on battery
S90	Load off
S91	Emergency power off
S92	Disconnected from the load

Table 7 – UPS status list

COMMANDS

These codes indicate that a command has been activated.

CODE	DESCRIPTION
C01	Remote off command
C02	Remote bypass command
C03	Remote on command
C04	Battery test active
C05	Manual bypass command
C06	Emergency off command
C07	Remote battery charger off command
C08	Bypass command active

Table 8 – UPS command list

WARNING

Messages that refer to a specific configuration or operation of the UPS.

CODE	DESCRIPTION
W01	Battery low warning
W02	Shutdown active
W03	Shutdown imminent
W04	Bypass disabled
W05	Synchronisation disabled
W07	Service UPS
W08	Service Battery
W09	BMS status - Warning
W10	BMS cmd - Stop charge
W11	BMS cmd - Stop discharge

Table 9 – UPS warning list

ANOMALIES

Minor problems that do not stop the operation of the UPS, but affect its performance or inhibit the use of some of its functions.

CODE	DESCRIPTION
A01	Configuration data corrupted
A02	Display error
A03	Inverter asynchronous
A04	External synchronism out of range
A05	Mains overvoltage L1
A06	Mains overvoltage L2
A07	Mains overvoltage L3
A08	Mains undervoltage L1
A09	Mains undervoltage L2
A10	Mains undervoltage L3
A11	Mains frequency abnormal
A12**	Input switch open
A13	Bypass voltage abnormal L1
A14	Bypass voltage abnormal L2
A15	Bypass voltage abnormal L3
A16	Bypass frequency abnormal
A17**	Bypass switch open
A18	Bypass voltage out of range
A22	Load > user threshold L1
A23	Load > user threshold L2
A24	Load > user threshold L3
A25	Output switch open
A26	(+) Battery not present
A27	(-) Battery not present
A29	System temperature sensor fault
A30	System undertemperature
A31	System overtemperature
A32	Boost undertemperature
A33	Inverter undertemperature
A37	External temperature probe fault
A38	External overtemperature
A39	Replace (+) battery
A40	Replace (-) battery
A42	Battery switch open
A43**	Alarm from input contact
A44	Main voltage out of range
// A47	Different firmware version
// A48	Anomaly on remote unit
A49	Date and time not set
A50	Calibration data error
A52	Output board data error
A53	BMS status - Anomaly
A54	BMS - Communication lost
A55	ENM - Communication lost

Table 10 – UPS alarm list (// = Parallel systems Anomaly)

**These anomalies are present only if the input signals are configured and programmed.

FAULTS

Faults are problems more critical than “Anomalies” in that, if they persist, they may bring the UPS to a stop.

CODE	DESCRIPTION
F01	Internal communication error
F02	Mains phases reversed
F03	Input fuse/contact fault L1
F04	Input fuse/contact fault L2
F05	Input fuse/contact fault L3
F06	Input contact short cct L1
F07	Input contact short cct L2
F08	Input contact short cct L3
F09	Precharge DC B+ bus error or precharge Cbatt+ failure
F10	Precharge DC B- bus error or precharge Cbatt- failure
F11	Boost fault
F12	Bypass phases reversed
F13	Boost voltage error
F14	Inverter sinewave abnormal L1
F15	Inverter sinewave abnormal L2
F16	Inverter sinewave abnormal L3
F17	Inverter error
F18	Output Vdc balance error
F19	Battery overvoltage B+
F20	Battery overvoltage B-
F21	Battery undervoltage B+
F22	Battery undervoltage B-
F23	Output overload
F24	Bypass not available
F25	Output negative power
F26	Output contact short cct L1
F27	Output contact short cct L2
F28	Output contact short cct L3
F29	Output fuse/contact fault L1
F30	Output fuse/contact fault L2
F31	Output fuse/contact fault L3
F32	Battery charger fault
F33	Battery measures error
F34	Power module overtemperature
F36	Fan fault
F37	Battery charger overtemperature
F38	BMS status - Fault
F39	Vdc bus measures error
F40	Battery fuse 1 fault B+
F41	Battery fuse 1 fault B-
F42	Battery fuse 2 fault B+
F43	Battery fuse 2 fault B-
// F45	Parallel link open
// F46	Parallel r_byp. line fault
// F47	Parallel synchronisation line fault
F48	Battery polarity error
F49	Battery contact 1 command fault
F50	Battery contact 2 command fault
F51	Battery contact 1 short cct
F52	Battery contact 2 short cct
F53	Bypass auxiliary power fault
F54	Memory access error
F56	Calibration error PFC
F57	Calibration error INV
F58	Calibration error BATT
F59	Output board communication error
F60	Communication board link fault
F61	Calibration error BYP
F63	Battery charger calibration error

Table 11 – UPS fault list (// = Parallel systems Anomaly)

LOCKS

Locks indicate a breakdown of the UPS or one of its parts. Locks are normally preceded by an alarm signal. In the event of a fault and resultant breakdown of the inverter, the inverter will be switched off and the load will be powered by the bypass line (this procedure is excluded for breakdowns caused by high and persistent overloads and by short circuits).

CODE	DESCRIPTION
L01	Auxiliary power fault
L02	Boards link fault
L03	Input fuse/contact fault L1
L04	Input fuse/contact fault L2
L05	Input fuse/contact fault L3
L06	Boost overvoltage B+
L07	Boost overvoltage B-
L08	Boost undervoltage B+
L09	Boost undervoltage B-
L10	Bypass backfeed
L11	Bypass output fault L1
L12	Bypass output fault L2
L13	Bypass output fault L3
L14	Inverter overvoltage L1
L15	Inverter overvoltage L2
L16	Inverter overvoltage L3
L17	Inverter undervoltage L1
L18	Inverter undervoltage L2
L19	Inverter undervoltage L3
L20	Inverter sinewave abnormal L1
L21	Inverter sinewave abnormal L2
L22	Inverter sinewave abnormal L3
L23	Output overload L1
L24	Output overload L2
L25	Output overload L3
L26	Output short-circuit L1
L27	Output short-circuit L2
L28	Output short-circuit L3
L29	Output fuse/contact fault L1
L30	Output fuse/contact fault L2
L31	Output fuse/contact fault L3
// L32	Parallel synchronisation Error
// L33	Parallel synchronisation line fault
L34	Boost overtemperature
L35	Inverter overtemperature
L37	Battery charger overtemperature
L38	Boost temperature sensor fault
L39	Inverter temperature sensor fault
L42	Battery fuse fault
L43	Battery contact short cct L1
L44	Input contact short cct L1
// L45	Parallel bus division
// L46	Parallel communication fault
// L47	Parallel board fault
L49	Output capacitor overtemperature
L51	Battery Charger short-circuit
// L52	Parallel P power error L1
// L53	Parallel P power error L2
// L54	Parallel P power error L3
// L55	Parallel Q power error L1
// L56	Parallel Q power error L2
// L57	Parallel Q power error L3
L58	BMS status - Lock

Table 12 – UPS lock list (// = Parallel systems Anomaly)

TROUBLESHOOTING GUIDE

Irregular operation of the UPS is very often not an indication of a fault but is simply caused by simple problems or distractions. We therefore recommend you consult the table here below, which provides some information that will help you to solve the most common problems.



WARNING: Table 13 below frequently recommends the use of the maintenance *BYPASS*. We remind you that before restoring the UPS to operation, you must make sure that it is on and **not in STAND-BY**. If the UPS is in this latter mode, turn on the UPS by accessing the “SYSTEM OFF/ON” menu and wait for the power-on sequence to be completed before removing the maintenance *BYPASS*. For further details **read the procedures described in the maintenance *BYPASS* (SWMB) chapter**.

NOTE: For a detailed explanation of the codes listed in Table 13, see the “STATUS/ALARM CODES” chapter.

PROBLEM	POSSIBLE CAUSE	SOLUTION
THE UPS IS COMPLETELY OFF (THE DISPLAY IS NOT TURNED ON)	MAINS VOLTAGE NOT PRESENT (BLACKOUT)	Check that the mains voltage is present. If necessary, power on the UPS from the battery to power the load.
	NO CONNECTION WITH INPUT TERMINALS	Connect the mains to the terminals as indicated in the Installation manual.
	INPUT ISOLATOR (SWIN) IS OPEN	Close the input isolator (SWIN)
	NO NEUTRAL CONNECTION	The UPS cannot work without a neutral connection. WARNING: If this connection is missing, damage could be caused to the UPS and/or the load. Connect the mains to the terminals as indicated in the Installation manual.
	UPSTREAM PROTECTIVE DEVICE OPEN	Reset the protective device. <u>Warning:</u> check that there is no overload or short-circuit at the output of the UPS.
THE LOAD IS NOT POWERED	NO CONNECTION WITH OUTPUT TERMINALS	Connect the load to the terminals
	OUTPUT ISOLATOR (SWOUT) IS OPEN	Close the output isolator (SWOUT)
	UPS IS IN STAND-BY	Execute the power-on sequence
	STAND-BY OFF MODE IS SELECTED	The operating mode must be changed. In fact, STAND-BY OFF (emergency) mode only powers the loads when a black out occurs.
	UPS FAILURE AND AUTOMATIC BYPASS OUT OF ORDER	Insert the maintenance bypass (SWMB) and call your local service centre
THE COMMUNICATION IS LOST, THE FANS ARE OFF BUT THE LOAD IS POWERED	DUE TO AN AUXILIARY SUPPLY FAULT, THE UPS IS IN BYPASS SUPPORTED BY THE REDUNDANT POWER SUPPLY	Activate the maintenance bypass (SWMB) shut down the UPS completely and wait for a few seconds. Try to switch it on again. If the display does not light up or the sequence fails, contact the nearest technical support centre and leave the UPS in manual bypass mode.
THE UPS RUNS ON BATTERY POWER EVEN WHEN THE MAINS VOLTAGE IS PRESENT	UPSTREAM PROTECTIVE DEVICE TRIPPED/BLOWN FUSE	Reset the protective device or replace the blown fuses. WARNING: Check that there is no overload or short circuit at the output of the UPS.
	INPUT VOLTAGE OUTSIDE TOLERANCE LIMITS FOR MAINS OPERATION	Verify the voltage measures in the “Mains Input page”. Problem caused by the mains. Wait for the input mains voltage to return within the tolerance limits. The UPS will return automatically to mains operation.
THE ALARM LIST SHOWS THE CODE S30	THE BATTERIES ARE DISCHARGED; THE UPS WAITS FOR THE BATTERY VOLTAGE EXCEEDING THE SET THRESHOLD	Wait for the batteries to recharge or force power on from the “Command panel”

PROBLEM	POSSIBLE CAUSE	SOLUTION
THE ALARM LIST SHOWS C01	THE JUMPER IS MISSING FROM THE R.E.P.O. CONNECTOR (REFER TO R.E.P.O - "COMMUNICATIONS" CHAPTER) OR THE CONNECTOR IS NOT INSERTED CORRECTLY	Assemble the jumper or check that it is inserted correctly.
THE ALARM LIST SHOWS C05	MAINTENANCE BYPASS ISOLATOR (SWMB) CLOSED	Verify if manual bypass switch (SWMB) is actually closed and why. If manual bypass is open contact your local service centre.
THE ALARM LIST SHOWS A01, A50	INCORRECT DATA CONFIGURATION	Check the settings
THE ALARM LIST SHOWS NOTHING, PROVIDES INCORRECT INFORMATION OR SHOWS A02	THE DISPLAY HAS POWER SUPPLY PROBLEMS	Close the Manual Bypass switch (SWMB) keeping closed the INPUT and OUTPUT switches. Open input switch (SWIN and SWBYP if present) and wait until the UPS completely turns OFF. Close the SWIN and SWBYP switches again and verify regular display operation. Switch off the maintenance bypass. If the fault persists, contact the nearest technical support centre.
THE ALARM LIST SHOWS ONE OR MORE OF THE FOLLOWING CODES: A08, A09, A10	ONE OR MORE PHASES ARE NOT CONNECTED	Check the input terminal connections
THE ALARM LIST SHOWS ONE OR MORE OF THE FOLLOWING CODES: A13, A14, A15	PROTECTIVE DEVICE UPSTREAM FROM THE BYPASS LINE OPEN (ONLY IF BYPASS IS SEPARATE)	Reset the protective device upstream. WARNING: check that there is no overload or short circuit at the output of the UPS
	BYPASS SWITCH OPEN (SWBYP ONLY IF BYPASS IS SEPARATE FROM MAINS)	Close the bypass switch (SWBYP) if present
THE ALARM LIST SHOWS ONE OR MORE OF THE FOLLOWING CODES: A26, A27	WRONG BATTERY CONNECTIONS OR BATTERY FUSES BLOWN	Verify battery connections and, if the connections are correct, replace the fuses or close the fuse holders (SWBATT). WARNING: if necessary, we recommend to replace fuses only with others of the same type. (for further information refer to the Installation manual).
THE ALARM LIST SHOWS ONE OR MORE OF THE FOLLOWING CODES: A30, A32, A33 AND THE UPS DOES NOT START	AMBIENT TEMPERATURE < 0°C	Heat-up the environment, wait for the heat sink temperature to rise above 0°C and then start up the UPS
	FAULT IN TEMPERATURE MEASURE SYSTEM	Activate the maintenance bypass (SWMB), turn the UPS off and on again and switch off the maintenance bypass. If the problem persists, call your local service centre
THE ALARM LIST SHOWS ONE OR MORE OF THE FOLLOWING CODES: A39, A40, F21, F22	THE BATTERIES FAILED THE PERIODIC EFFICIENCY TEST	The batteries of the UPS should be replaced as they are no longer able to maintain the charge for a sufficient time to ensure the required autonomy. WARNING: The batteries are to be replaced by qualified staff.
THE ALARM LIST SHOWS ONE OR MORE OF THE FOLLOWING CODES: F09, F10	FAULT AT THE UPS INPUT STAGE	Activate the maintenance bypass (SWMB), turn the UPS off and on again. Exclude the maintenance bypass. If the problem persists, call your local service centre.
	VOLTAGES HAVE UNBALANCED RMS VALUES	Open SWIN, turn the UPS on from the battery (see the cold start procedure), wait for the end of the sequence and close SWIN.

PROBLEM	POSSIBLE CAUSE	SOLUTION
THE ALARM LIST SHOWS ONE OR MORE OF THE FOLLOWING CODES: F11, F13, F14, F15, F16, F17, L06, L07, L08, L09, L14, L15, L16, L17, L18, L19, L20, L21, L22	FAULTY LOADS APPLIED	Remove the load. Insert the maintenance bypass (SWMB), and turn the UPS off and then on again. Switch off the maintenance bypass. If the problem persists, call your local service centre
	FAULT IN THE INPUT OR OUTPUT STAGE OF THE UPS	Activate the maintenance bypass (SWMB) and turn the UPS off and then on again. Switch off the maintenance bypass. If the problem persists, call your local service centre
THE ALARM LIST SHOWS ONE OR MORE OF THE FOLLOWING CODES: F19, F20	BATTERY CHARGER FAULT	Open the battery fuse holders (SWBATT), insert the maintenance bypass (SWMB), shut down the UPS completely and contact the nearest technical support centre.
THE ALARM LIST SHOWS ONE OR MORE OF THE FOLLOWING CODES: F23, L23, L24, L25, A22, A23, A24	THE LOAD APPLIED TO THE UPS IS TOO HIGH	Reduce the load
THE ALARM LIST SHOWS ONE OR MORE OF THE FOLLOWING CODES: F26, F27, F28, F29, F30, F31, L29, L30, L31	INTERNAL PROTECTIVE FUSES BLOWN ON THE PHASES OR INPUT RELAY BROKEN	Call your local service centre
THE ALARM LIST SHOWS ONE OR MORE OF THE FOLLOWING CODES: F34, L34, L35, A31	<ul style="list-style-type: none"> ▪ SYSTEM TEMPERATURE OVER 50°C ▪ HEAT SOURCES CLOSE TO THE UPS ▪ VENTILATION SLITS OBSTRUCTED OR TOO CLOSE TO WALLS 	Activate the maintenance bypass (SWMB) without powering off the UPS; in this way, the fans cool the heat sink more quickly. Eliminate the cause of the over-temperature and wait for the temperature of the heat sink to drop. Switch off the maintenance bypass.
	FAULT IN TEMPERATURE PROBE OR UPS COOLING SYSTEM	Insert the maintenance bypass (SWMB) without turning off the UPS so that the fans, continuing to run, cool down the heat sink more quickly and wait for the temperature of the heat sink to drop. Turn the UPS off and then on again. Switch off the maintenance bypass. If the problem persists, call your local service centre.
THE ALARM LIST SHOWS ONE OR MORE OF THE FOLLOWING CODES: F40, F41, F42, F43, L42	THE INTERNAL PROTECTION FUSES ON THE BATTERIES HAVE BLOWN OR BATTERY RELAY IS BROKEN	Call the nearest service centre.
THE ALARM LIST SHOWS ONE OR MORE OF THE FOLLOWING CODES: F49, F50, F51, F52, L43	COMMAND RELAY OR BATTERY RELAY LOCKED	Call the nearest service centre.
THE ALARM LIST SHOWS ONE OR MORE OF THE FOLLOWING CODES: L01, L38, L39	FAULT IN: <ul style="list-style-type: none"> ▪ MAIN AUXILIARY POWER SUPPLY ▪ TEMPERATURE PROBE OR UPS COOLING SYSTEM 	Activate the maintenance bypass (SWMB), turn the UPS off and then on again. Switch off the maintenance bypass. If the problem persists, call your local service centre
THE ALARM LIST SHOWS ONE OR MORE OF THE FOLLOWING CODES: L10, L11, L12, L13	BREAKDOWN OR MALFUNCTIONING OF THE STATIC BYPASS	Activate the maintenance bypass (SWMB), switch the UPS off and then on again. Switch off the maintenance bypass. If the fault persists, contact the nearest technical support centre
THE ALARM LIST SHOWS ONE OR MORE OF THE FOLLOWING CODES: L26, L27, L28	OUTPUT SHORT CIRCUIT	Power off the UPS. Disconnect all the devices connected to the phase concerned by the short circuit. Turn the UPS on again. Reconnect the devices one by one until the faulty one is identified.
THE ALARM LIST SHOWS ONE OR MORE OF THE FOLLOWING CODES: A53, A54, A55, F38, L58	FAULT IN OF THE ENERGYMANAGER	Check that the EnergyManager accessory is connected correctly.

Table 13 – Troubleshooting

PREVENTIVE MAINTENANCE

INTRODUCTION

Our UPS are designed and produced for long life even under the severest operating conditions. Remember however that they are electrical power equipment items and as such are in need of periodic checks. Besides, some components have a life cycle of their own and must therefore be checked at regular intervals and may need to be replaced, due to the conditions; in particular: the batteries, the fans, the electrolytic and the film capacitors.

It's very important to check the requirements and the suggestions for the installation environment given in the "Installation manual". Moreover, it is recommended to implement a preventive maintenance program, using the manufacturer authorised and trained service personnel.

During the Maintenance all the electronics and the mechanicals parts will be controlled. This will improve the reliability, maintain the UPS efficiency to the maximum level and to extend the lifespan.

The product safety preservation over the time is ensured with a preventive and regular maintenance program on the UPS.



Only the authorised and trained service personnel can perform any maintenance operations.

Our Technical Servicing department is at your disposal to discuss the different personalised preventive maintenance options.

BATTERIES

Thanks to an advanced battery care system our UPS preserve the batteries health both during charging and discharging phase. For example an algorithm to avoid deep discharge is implemented. Anyway environmental condition and usage affect battery life. Ambient temperature, number of blackout or outages, number of depth discharges, frequency of charge and discharge cycles are the key factors that affect battery life. In order to avoid unexpected behavior during a mains outage, batteries should be regularly checked and maintained by authorised service personnel.

FANS

The Fans fitted in this UPS are speed controlled. Ambient temperature and UPS output power affect the speed. In addition, dusty environments can make matters worse. Preventive maintenance ensures that the cooling system is kept in perfect working order.

CAPACITORS

The most critical capacitors inside the UPS are the electrolytic capacitors fitted within the intermediate DC BUS and the AC film capacitors used for input and output high frequency filtering. For our UPS we have select the best components available on the market from well-known brands and we size them for the maximum reliability. The expected life depends however on the usage and environmental conditions. Preventive maintenance thanks to a periodic check of the capacitors ensures the highest level of system reliability.

TECHNICAL DATA TABLE

S3T 80 / 100 / 120 kVA		
INPUT		
Rated voltage [V]	400 (3PH + N)	
Rated frequency [Hz]	50-60	
Accepted tolerance for input voltage [%] ¹	±20 @ 100% load -40 +20 @50% load	
Accepted tolerance for input frequency [Hz] ²	40-72	
Technology	IGBT high frequency with PFC control, independent digital average current mode on each input phase	
Input current harmonic distortion [%] ³	THDi ≤ 3	
Input power factor	≥0.99	
Power Walk-in	Programmable from 1 to 120 sec. in steps of 1 sec.	
Inrush Current	I _{max} < I _n	
OUTPUT		
Rated voltage [V]	380-400-415 (3PH + N)	
Rated frequency [Hz]	50/60	
Rated apparent output power [kVA]	80 / 100 / 120	
Rated active output power [kW]	80 / 100 / 120	
Output power factor	1	
Precision of output voltage (with respect to 400 (230) Vac output voltage) [%]	± 1	
Static stability [%]	± 0.5	
Dynamic stability	EN62040 -3 Performance Class 1	
Output voltage harmonic distortion with standardized resistive linear and non-linear load [%]	< 1% with resistive linear load ≤1.5% with non-linear load	
Crest factor allowed at rated load	3:1	
Precision of frequency in free running mode [%]	0.01	
Inverter overload ⁶	103% Infinite, 110% 60 min, 125% 10 min, 150% 1 min	
Bypass Overload	110% Infinite, 125% 60 min, 150% 10 min, 200% 1 min, >200% 20 sec	
Technology	High frequency IGBT with digital control	
BATTERIES		
Rated voltage [Vdc]	± 240	
Standard maximum recharging current [A]	12 (80-100kVA models) - 30 (120kVA models)	
Battery charger algorithm	Two levels with temperature compensation	
Technology	Digital controlled PWM regulation	
Tolerance of input voltage for recharging at maximum current [V]	365-480	
MISCELLANEOUS		
Audible noise [dB(A)] ⁴	< 54	
Color	RAL 7016	
Operating ambient temperature	0 – 40 °C	
DIMENSIONS AND WEIGHT ⁵		
W x D x H [mm]	500 x 850 x 1600	
Weight [kg]	80kVA	172
	100kVA	180
	120kVA	198

Table 14 – UPS main technical data table

¹ Without battery intervention (for 400Vac)

⁴ Noise level @ 1m (db(A) ±2, in SMART ACTIVE mode

² Without battery intervention (for 50/60Hz)

⁵ Without packaging

³ With full load and source THDv <1%

⁶ Conditions apply

